



ETA-Danmark A/S  
Göteborg Plads 1  
DK-2150 Nordhavn  
Tel. +45 72 24 59 00  
Internet [www.etadanmark.dk](http://www.etadanmark.dk)

Authorised and notified  
according to Article 29 of the  
Regulation (EU)  
No 305/2011 of the European  
Parliament and of the Council  
of 9 March 2011

MEMBER OF EOTA



## European Technical Assessment ETA-20/1233 of 2020/12/20

### I General Part

**Technical Assessment Body issuing the ETA and designated according to Article 29 of the Regulation (EU) No 305/2011: ETA-Danmark A/S**

**Trade name of the construction product:**

Hilti Firestop Cast In Device CFS-CID

**Product family to which the above construction product belongs:**

Firestop Collar for Use in penetrations Seals

**Manufacturer:**

Hilti AG  
Feldkircherstraße 100  
DE-9494 Schaan  
Liechtenstein  
Telephone +49 423 234 21 11  
Internet: [www.hilti.group](http://www.hilti.group)

**Manufacturing plant:**

Hilti Plant 4a  
Hilti Plant 5a  
Hilti Plant 14

**This European Technical Assessment contains:**

33 pages including 4 annexes which form an integral part of the document

**This European Technical Assessment is issued in accordance with Regulation (EU) No 305/2011, on the basis of:**

EAD 350454-00-1104 Fire stopping and fire sealing products, Penetration Seals  
Issued September 2017

**This version replaces:**

-

**Translations of this European Technical Assessment in other languages shall fully correspond to the original issued document and should be identified as such.**

**Communication of this European Technical Assessment, including transmission by electronic means, shall be in full [except the confidential Annex(es) referred to above]. However, partial reproduction may be made with the written consent of the issuing Technical Assessment Body. Any partial reproduction has to be identified as such.**

## 1 Technical Description of the Product

### 1.1 Definition of the construction product

This European technical assessment refers to the Hilti Firestop Cast-in Device for use in Penetration Seals with the designation Hilti CFS-CID.

Hilti Firestop Cast-in Device CFS-CID is a pipe closure device that is cast into rigid floors. Ancillary products referred to in this European technical assessment within the framework of evaluating resistance to fire (see Annexes 1 and 2) are not covered by this ETA and cannot be CE-marked on the basis of it.

Type of penetration seal system: Pipe closure device – cast in (see EAD 350454-00-1104, clause 1.1, table 1-1). Hilti Firestop Cast-in Device CFS-CID consists of a plastic housing, an intumescent inlay and rubber seal for the purpose of smoke and draft stop, air or water tightness and airborne sound insulation.

Hilti Firestop Cast-in Device CFS-CID is supplied in several sizes – see table below.

Pipe sealing size	For plastic pipes with nominal outside diameter range (mm)	For insulated metal pipes	
		nominal outside diameter range (mm)	nominal pipe insulation range (mm)
CFS-CID 50	32 - 63	18 - 54	8 - 38
CFS-CID 75	50 - 75		
CFS-CID 110	90 - 110	54 - 76	14 - 40,5
CFS-CID 160	125 - 160		

For a description of the installation procedure see 3.1 and 3.2

## **2 Specification of the intended use(s) in accordance with the applicable European Assessment Document (hereinafter EAD)**

Hilti Firestop Cast-in Device CFS-CID is intended to form a part of a penetration seal, which is used to maintain the fire resistance of a separating element (rigid floor) when and where services with plastic, composite pipes and insulated metal pipes as single penetrations pass through.

Annex 2 gives details of penetration for which fire resistance tests were carried out. This ETA covers assemblies installed in accordance with the provisions given in Annex 2.

For details on diameters, wall thicknesses, pipe materials, pipe insulation and pipe standards see Annex 2.

Pipes shall be perpendicular to the seal surface. The pipe penetration seal is intended for in piping systems for non-combustible liquids and fluids, for pneumatic dispatch systems and for pipes in centralised vacuum-cleaning systems.

The assessment does not cover the avoidance of destruction of the seal or of the abutting building element(s) by forces caused by temperature changes in case of fire. This has to be considered when designing the piping system.

The provisions made in this European Technical Assessment are based on an assumed working life of the Hilti Firestop Cast-in Device CFS-CID of 10 years, provided that the conditions laid down in the manufacturer's datasheet and instructions for the packaging / transport / storage / installation / use / repair are met.

The indications given on the working life cannot be interpreted as a guarantee given by the producer or the Technical Assessment Body but are to be regarded only as a means for choosing the right products in relation to the expected economically reasonable working life of the works.

### **2.1 Use category**

Hilti Firestop Cast-in Device CFS-CID fulfils the requirements of use category Y<sub>2</sub> in accordance with EAD 350454-00-1104, Section 1.2.1

Type Y<sub>2</sub>: Products intended for uses at internal conditions

### **2.2 General assumptions**

For evaluating resistance to fire of the penetration seal using "Hilti Firestop Cast-in Device CFS-CID" as specified in Annex 2 it is assumed that:

- the installation of the penetration seal does not affect the stability of the adjacent building elements – even in case of fire,
- the installations are fixed to the adjacent building elements (not to the seal) in accordance with the relevant regulations in such a way that, in case of fire, no additional mechanical load is imposed on the seal, the support of the installations is maintained for the classification period required and
- pneumatic dispatch systems, compressed air systems, etc. are switched off by additional means in case of fire.

This European technical assessment does not address any risks associated with the emission of dangerous liquids or gases caused by failure of the pipe(s) in case of fire nor does it prove the prevention of the transmission of fire through heat transfer via the medium in the pipes.

This European technical assessment does not verify the prevention of destruction of adjacent building elements with fire separating function or of the pipes themselves due to distortion forces caused by extreme

temperatures. These risks shall be accounted for by taking appropriate measures when designing or installing the pipe work.

The mounting or hanging of the pipes or the layout of the pipe work shall be implemented in such a way that the pipes and the fire-resistant building elements shall remain functional for at least ... minutes (corresponding to the target period of fire resistance).

The risk of downward spread of fire caused by burning material which drips through a pipe to floors below, is not considered in this ETA (see EN 1366-3: 2009-07, section 1).

The durability assessment does not take account of the possible effect on the penetration seal of substances permeating through pipe floors.

### **2.3 Installation**

The arrangement and installation of Hilti Firestop Cast-in Device CFS-CID shall be done in accordance with the details given in Annex 2 and Annex 3 for the penetration seal(s).

### 3 Performance of The Product And References To The Methods Used For Its Assessment

Basic requirements for construction works	Essential characteristics	Method of verification	Performance
<b>BWR 1</b>	None	Not relevant	
<b>BWR 2</b>	Reaction to fire	EN 13501-1	Class E
	Resistance to fire	EN 13501-2:2007+A1:2009	See annex 2
<b>BWR 3</b>	Air permeability (material property)	No performance assessed	
	Water permeability (material property)	No performance assessed	
	Content and/or release of dangerous substances	European Council Directive 67/548/EEC- Dangerous Substances Directive and Regulation (EC) No 1272/2008, see clause 3.3.1	Declaration of conformity by the manufacturer
<b>BWR 4</b>	Mechanical resistance and stability	Not relevant	
	Resistance to impact / movement	No performance assessed	
	Adhesion	See clause 3.4.2	
<b>BWR 5</b>	Airborne sound insulation	See clause 3.5.1	
<b>BWR 6</b>	Thermal properties	No performance assessed	
	Water vapour permeability	No performance assessed	
<b>BWR 7</b>	No performance assessed		

### **3.1 Safety in case of fire**

#### **3.1.1 Reaction to fire**

The components of construction product Hilti Firestop Cast-in Device CFS-CID are classified according to EN 13501-1.

<b>Component</b>	<b>Class according to EN 13501-1</b>
CFS-CID	E

#### **3.1.2 Resistance to fire**

The resistance to fire performance according to EN 13501-2 of penetration seals made of Hilti Firestop Cast-in Device CFS-CID is given in Annex 2.

### **3.2 Hygiene, Health, and the environment.**

#### **3.2.1. Content and release of Dangerous Substances**

Hilti AG have presented a Material Safety Data Sheet according to 91/155 EEC and a declaration that Hilti Firestop Cast-in Device CFS-CID is in compliance with Council Directive 76/769/EEC of 27th July 1976 on the approximation of the laws, regulations and administrative provisions of the Member States relating to restrictions on the marketing and use of certain dangerous substances and preparations (incl. all amendments and adaptations).

In addition to the specific clauses relating to dangerous substances contained in this ETA, there may be other requirements applicable to the products falling within its scope (e.g. transposed European legislation and national laws, regulations and administrative provisions). In order to meet the provisions of the Construction Product Regulation, these requirements need also to be complied with, when and where they apply.

### **3.3 Safety and accessibility in use**

#### **3.3.1 Mechanical resistance and stability**

No performance assessed

#### **3.3.2 Resistance to impact/movement**

No performance assessed

#### **3.3.3 Adhesion**

The fixing of the Cast-in Device must be done according to the provisions given in Annex 3.

### **3.4 Protection against noise**

#### **3.4.1 Airborne sound insulation**

Airborne sound insulation for a single penetration of a plastic pipe, fire stopped with Firestop Cast-in Device CFS-CID can only be achieved when the pipe closure device is casted in rigid floor.

Test reports from noise reduction according to EN ISO 10140-1: 2010 + A1: 2012 + A2: 2014, EN ISO 10140-2: 2010 and EN ISO 717-1: 2013 have been provided.

The acoustic tests were performed in a rigid wall. Hilti Firestop Cast-in Device CFS-CID 50, 75, 110 and 160 was tested in combination with a plastic pipe. The acoustic characteristics of the walls itself have not been measured. According to these tests reports the single number ratings are:

Rigid floor:

Assessed standard level difference:

CFS-CID 50 and plastic pipe:  $D_{n,e,w}$  (C; Ctr) = 55 (-3;-2) dB

CFS-CID 50 blank version:  $D_{n,e,w}$  (C; Ctr) = 62 (-1;-2) dB

CFS-CID 75 and plastic pipe:  $D_{n,e,w}$  (C; Ctr) = 51 (-1;-1) dB

CFS-CID 75 blank version:  $D_{n,e,w}$  (C; Ctr) = 56 (-1;-2) dB

CFS-CID 110 and plastic pipe:  $D_{n,e,w}$  (C; Ctr) = 48 (-1;0) dB

CFS-CID 110 blank version:  $D_{n,e,w}$  (C; Ctr) = 53 (-1;-2) dB

CFS-CID 160 and plastic pipe:  $D_{n,e,w}$  (C; Ctr) = 46 (0;0) dB

CFS-CID 160 blank version:  $D_{n,e,w}$  (C; Ctr) = 45 (-3;-5) dB

From this  $D_{n,e,w}$  the assessed standard level calculates to:  $R_w$  (C;Ctr) = 61 (-3;-7) dB

Structure of the rigid wall: 150 mm thick concrete wall with a density of 2000 kg/m<sup>3</sup>

It should be noticed that both above mentioned results apply to the total wall construction of the size

$S = 1,23 \text{ m} \times 1,48 \text{ m} (= 1,82 \text{ m}^2)$ .

$D_{n,e,w}$ : Assessed standard level difference of small building elements (given with spectrum adaptation terms C and Ctr)

$R_w$ : Assessed standard level (given with spectrum adaptation terms C and Ctr)

### **3.5 Energy, economy and heat retention (BWR 6)**

#### **3.5.1 Thermal properties**

No performance assessed

#### **3.5.2 Water vapour permeability**

No performance assessed



#### **4 Assessment and verification of constancy of performance (hereinafter AVCP) system applied, with reference to its legal base**

According to the Decision 1999/454/EC, amended by Decision 2001/596/EC of the European Commission, as amended, the system(s) of assessment and verification of constancy of performance AVCP (see Annex V of Regulation (EU) No 305/2011) is 1.

#### **5 Technical details necessary for the implementation of the AVCP system, as provided for in the applicable EAD**

Technical details necessary for the implementation of the AVCP system are laid down in the control plan deposited at ETA-Danmark A/S prior to CE marking

Issued in Copenhagen on 2020-12-20 by

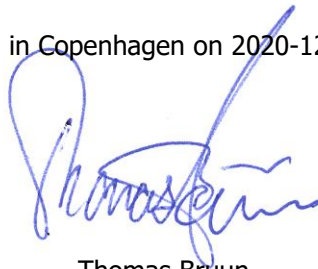

Thomas Bruun

Managing Director, ETA-Danmark

## **ANNEX 1**

### **DESCRIPTION OF THE PRODUCT AND ANCILLARY PRODUCT(S)**

#### **Hilti Firestop Cast-in Device CFS-CID**

The Cast-in device consists of a plastic housing, an inlay with different number of intumescent layers, and a rubber gasket.

In case of greater floor thicknesses (>150mm) the Cast-in device length can be increased through an extension tube.

Manifold adapter to create a spacing of 280 x 280 x 75 mm.

A detailed specification of the product is contained in document "Identification / Product Specification relating to the European technical assessment ETA – 16/0383 Hilti Firestop Cast-in Device CFS-CID" which is a non-public part of this ETA.

The Control Plan defined in document "Control Plan is relating to the European technical assessment ETA – 16/0383 Hilti Firestop Cast-in Device CFS-CID" which is a non-public part of this ETA.

#### **Technical product literature:**

Installation instruction Hilti Firestop Cast-in Device CFS-CID (according to Annex 3).

**ANNEX 2****RESISTANCE TO FIRE CLASSIFICATION OF PENETRATION SEALS MADE OF HILTI FIRESTOP Cast-in Device CFS-CID****Overview intended use of pipes<sup>1</sup> and reference to relevant section**

Application	Pipe material	Standard	Insulation	Diameter (mm)	Distance (s <sub>1</sub> ) (mm)	Fire resistance Classification	Rigid floor ≥ 550 kg/m <sup>3</sup>
							Details (see section)
<b>Waste water Roof Drainage</b>	PE (PE-HD)	EN 1519-1, EN 12666-1 (covers EN 12201-2, EN 1519-1, EN 12666-1, EN 1455-1 (ABS), EN 1565-1 (SAN+PVC))	-	40 - 160	200	EI 180	2.2.1.1
					0	EI 120	
	PE	EN ISO 15494, DIN 8074	-	50 - 160	200	EI 180	2.2.1.2
					0	EI 120	
	PE-S2 Geberit dB20	Non regulated	-	56 - 160	200	EI 180	2.2.2
					0	EI 120	
	PVC-U	EN 1329-1 or EN 1453-1 or EN 1452-1 (covers EN 1329-1, EN 1453-1, EN 1566-1), EN ISO 15493 (Industrial, equivalent EN 1452)	-	63 - 160	200	EI 180	2.2.3
					50 - 160	0	EI 120
	PP	EN 1451-1 (DIN 4102)	-	40 - 160	200	EI 180	2.2.5
					0	EI 120	
<b>Drinking water</b>	PP-R	DIN 8077/8078	-	32 - 160	200	EI 180	2.2.6
	PE-Xa	Non-regulated (Rehau Rautitan Flex)	-	32 - 63	200	EI 180	2.2.7
					0	EI 120	
	PE-X	Non-regulated (e.g. Geberit Mepla, etc.)	Elastomeric	40	200	EI 180	2.2.8
					0	EI 120	

<sup>1</sup> According to technical literature of pipe manufacturers

Application	Pipe material	Standard	Insulation	Diameter (mm)	Distance (s <sub>1</sub> ) (mm)	Fire resistance Classification	Rigid floor ≥ 550 kg/m <sup>3</sup>
							Details (see section)
Heating	Copper and Steel	DIN 1786/1754,	Elastomeric	18 - 76	200	EI 180	2.2.9
					200	EI 120	2.2.10
			Glass wool	18 - 76	0	EI 120	2.2.11
			Mineral wool	18 - 89	200	EI 180	2.2.12
Elbow	PE (PE-HD)	EN 1519-1, EN 12666-1 (covers EN 12201-2, EN 1519-1, EN 12666-1, EN 1455-1 (ABS), EN 1565-1 (SAN+PVC))	-	110	200	EI 180	2.2.13
	PVC	EN 1519-1, EN 12666-1 (covers EN 12201-2, EN 1519-1, EN 12666-1, EN 1455-1 (ABS), EN 1565-1 (SAN+PVC))					
Blank	-	-	-	-	200	EI 180	2.2.14
					0	EI 120	2.2.15
Manifold	-	-	-	-	200	EI 180	3.1

## 2.1 General information

### 2.1.1 Rigid floor

The floor must have a minimum thickness of 150 mm and comprise concrete with a minimum density of 550 kg/m<sup>3</sup>.

### 2.1.2 Penetration seal:

Single penetration;

Hilti Firestop Cast-In CFS-CID on the underside of the floor

### 2.1.3 Distance between penetrations:

Minimum distance between Cast-In / annular gap edge (s<sub>1</sub>):

**A:** Non-insulated pipes: s<sub>1</sub> (0 mm)

Insulated pipes: s<sub>1</sub> (0 mm)

**B:** Non-insulated pipes: s<sub>1</sub> (200 mm)

Insulated pipes: s<sub>1</sub> (200 mm)

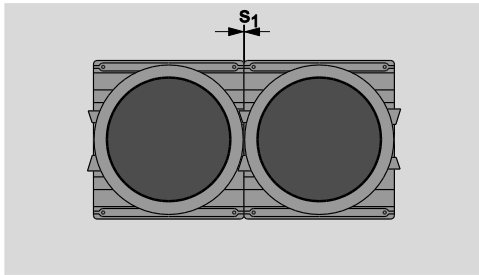

Note: s<sub>1</sub> (0 mm) = EI 120

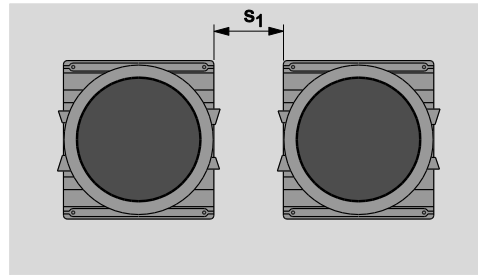

s<sub>1</sub> (200 mm) = EI 180

#### 2.1.4.1 Pipes provided with foamed elastomeric insulation.

The following types of foamed elastomeric insulation material may be used in direct contact

(s<sub>1</sub> ≥ 0 mm) to Hilti Firestop Cast-in Device CFS-CID:

Producer	Approved Type of foamed elastomeric thermal isolation
Armacell GmbH	<ul style="list-style-type: none"> <li>Armaflex AF, Armaflex SH, Armaflex Ultima, Armaflex HT</li> </ul>
NMC Group	<ul style="list-style-type: none"> <li>Insul-Tube (nmc), Insul-Tube H-Plus (nmc),</li> </ul>
Kaimann GmbH	<ul style="list-style-type: none"> <li>Kaiflex KK plus, Kaiflex KK,</li> </ul>
L'Isolante K-Flex	<ul style="list-style-type: none"> <li>l'Isolante K-Flex HT, l'Isolante K-Flex ECO, l'Isolante K-Flex ST, l'Isolante K-Flex H, l'Isolante K-Flex ST Plus</li> </ul>

Named material may be used in form of an insulation hose, bandage/wrap or plates. If a protect insulation D<sub>p</sub> is used, it should be made of the same elastomeric material as the thermal pipe isolation itself.



**2.2 Penetrating services approved with CFS-CID****2.2.1 PE pipes****Pipe end configuration: U/U****Distance of penetrations ( $s_1$ ): 200 mm****2.2.1.1 PE pipes according to EN 1519-1, EN 12666-1, EN 12201-2****Pipe end configuration: U/U****Distance of penetrations ( $s_1$ ): 0mm / 200 mm (B)**

Collar size ( $A_1$ )	Pipe diameter $d_c$ (mm)	Pipe wall thickness $t_c$ (mm)	Classification with Distance ( $s_1$ ) 0mm	Classification with Distance ( $s_1$ ) 200mm
CFS-CID 50	40	3,0	EI 120-U/U	EI 180-U/U
	50	3,0		
	63	3,0		
	<b>40 - 63</b>	<b>3,0</b>		
CFS-CID 75	75	3,0		
CFS-CID 110	90	3,5		
	110	4,2		
	<b>90 - 110</b>	<b>3,5/4,2<sup>(1)</sup></b>		
CFS-CID 160	125	4,8		
	160	6,2		
	<b>125 - 160</b>	<b>4,8/6,2<sup>(1)</sup></b>		

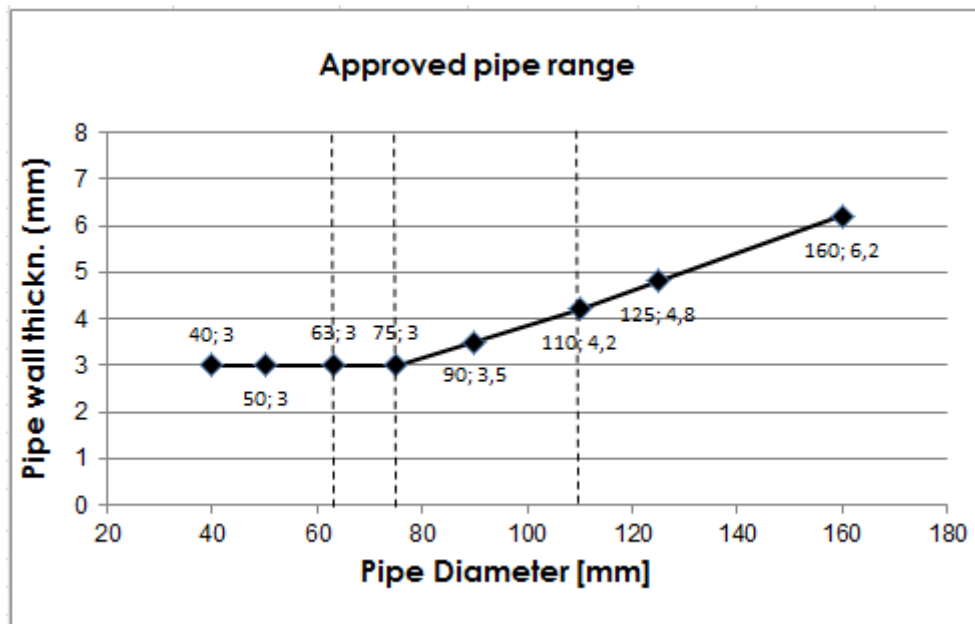
<sup>(1)</sup> interpolation of min. pipe wall thickness within pipe diameter range

**2.2.1.2 PE pipes according to EN ISO 15494 and DIN 8074/8075****Pipe end configuration: U/C****Distance of penetrations ( $s_1$ ): 0mm / 200 mm (B)**

Collar size ( $A_1$ )	Pipe diameter $d_c$ (mm)	Pipe wall thickness $t_c$ (mm)	Classification with Distance ( $s_1$ ) 0mm	Classification with Distance ( $s_1$ ) 200mm
CFS-CID 50	50	2,9	EI 120-U/U	EI 180-U/U
	63	1,8		
	63	8,6		
	<b>50 - 63</b>	<b>1,8/1,8<sup>(1)</sup> - 8,6</b>		
CFS-CID 75	75	1,9		
	75	6,8		
	<b>75</b>	<b>1,9<sup>(1)</sup> to 6,8</b>		
CFS-CID 110	90	2,2		
	110	2,7		
	110	10,0		
	<b>90 - 110</b>	<b>2,2/2,7<sup>(1)</sup> - 10,0</b>		
CFS-CID 160	125	3,1		
	160	4,0		
	160	9,1		
	<b>125 - 160</b>	<b>3,1/4,0<sup>(1)</sup> - 9,1</b>		

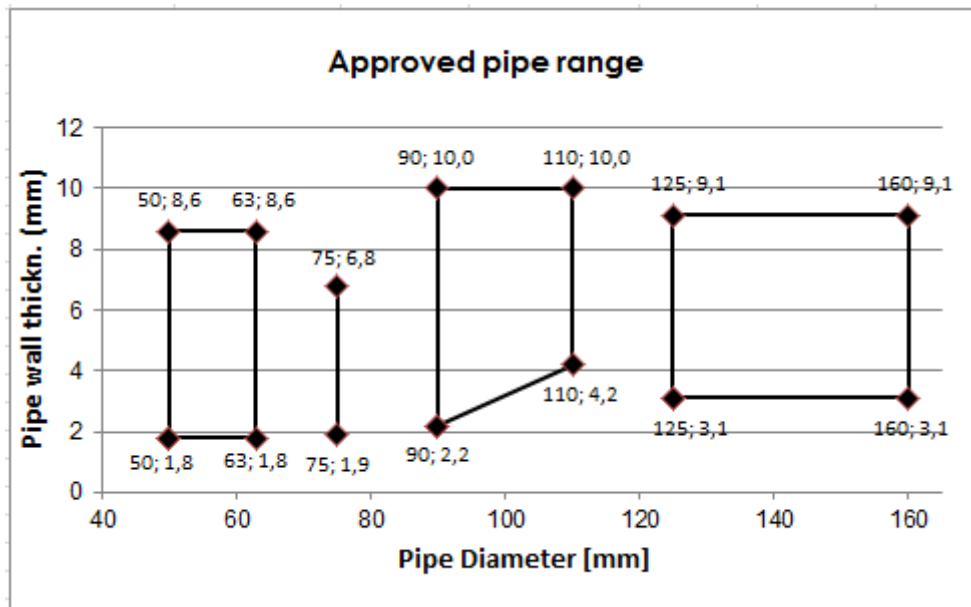
<sup>(1)</sup> interpolation of min. pipe wall thickness within pipe diameter range



**2.2.2 PE-S2 pipes, designation "Geberit Silent dB20"****Pipe end configuration: U/U****Distance of penetrations ( $s_1$ ): 0mm / 200 mm (B)**

Collar size ( $A_1$ )	Pipe diameter $d_c$ (mm)	Pipe wall thickness $t_c$ (mm)	Classification with Distance ( $s_1$ ) 0mm	Classification with Distance ( $s_1$ ) 200mm
CFS-CID 50	56	3,2	EI 120-U/U	EI 180-U/U
CFS-CID 75	56	3,2		
	75	3,6		
	<b>56 - 75</b>	<b>3,2/3,6<sup>(1)</sup></b>		
CFS-CID 110	90	5,5		
	110	6,0		
	<b>90 - 110</b>	<b>5,5/6,0<sup>(1)</sup></b>		
CFS-CID 160	135	6,0		
	160	7,0		
	<b>135 - 160</b>	<b>6,0/7,0<sup>(1)</sup></b>		

(1) interpolation of min. pipe wall thickness within pipe diameter range

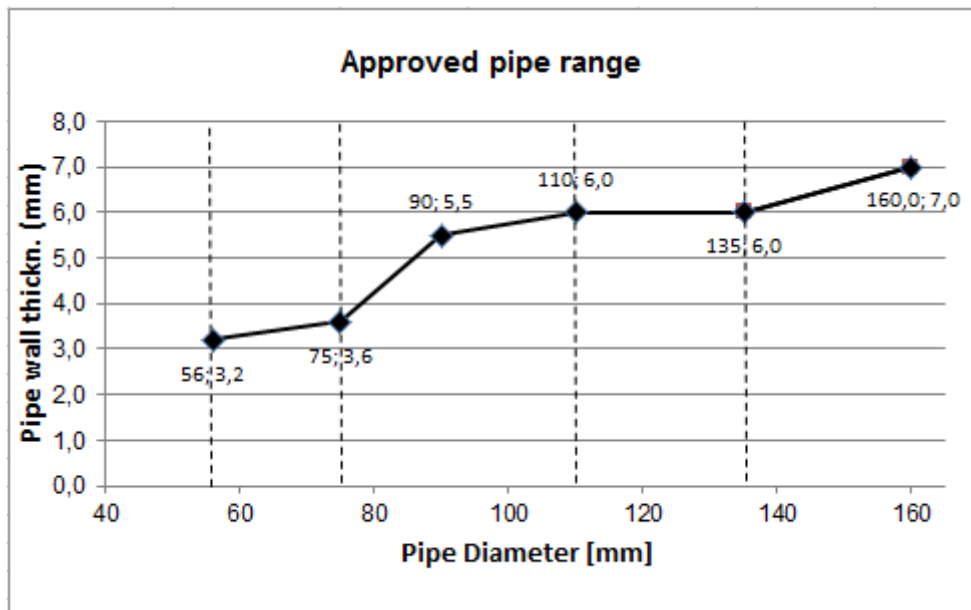

**2.2.3 PVC pipes acc. to EN 1452-2, EN 1329-1, EN 1453-1****Pipe end configuration: U/U****Distance of penetrations ( $s_1$ ): 200 mm (B)**

Collar size ( $A_1$ )	Pipe diameter $d_c$ (mm)	Pipe wall thickness $t_c$ (mm)	Classification with Distance ( $s_1$ ) 200mm
CFS-CID 50	63	1,6	EI 180-U/U
	63	7,0	
	<b>63</b>	<b>1,6 - 7,0</b>	
CFS-CID 75	75	8,4	
CFS-CID 110	80	1,8	
	110	8,1	
	<b>80 - 110</b>	<b>1,8/8,1<sup>(1)</sup></b>	
CFS-CID 160	125	1,8	

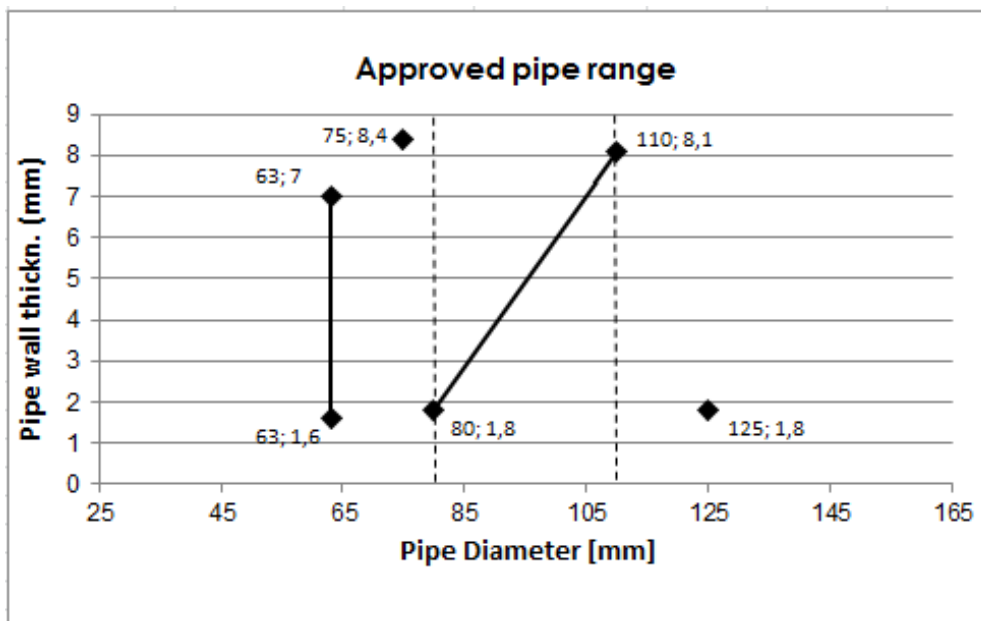
<sup>(1)</sup> interpolation of min. pipe wall thickness within pipe diameter range

**2.2.4 PVC pipes acc. to EN 1452-2, EN 1329-1, EN 1453-1****Pipe end configuration: U/U****Distance of penetrations ( $s_1$ ): 0 mm (A)**

Collar size ( $A_1$ )	Pipe diameter $d_c$ (mm)	Pipe wall thickness $t_c$ (mm)	Classification with Distance ( $s_1$ ) 0mm
CFS-CID 50	50	2,4	EI 120-U/U
	63	1,6	
	63	7,0	
	<b>50 - 63</b>	<b>1,6/1,6<sup>(1)</sup> - 7,0</b>	
CFS-CID 75	75	2,2	
	75	8,4	
	<b>75</b>	<b>2,2 - 8,4</b>	
CFS-CID 110	80	1,8	
	110	1,8	
	110	8,1	
	<b>80 - 110</b>	<b>1,8/1,8<sup>(1)</sup> - 8,1</b>	
CFS-CID 160	125	1,8	
	160	3,2	
	160	7,7	
	<b>125 - 160</b>	<b>1,8/3,2<sup>(1)</sup> - 7,7</b>	

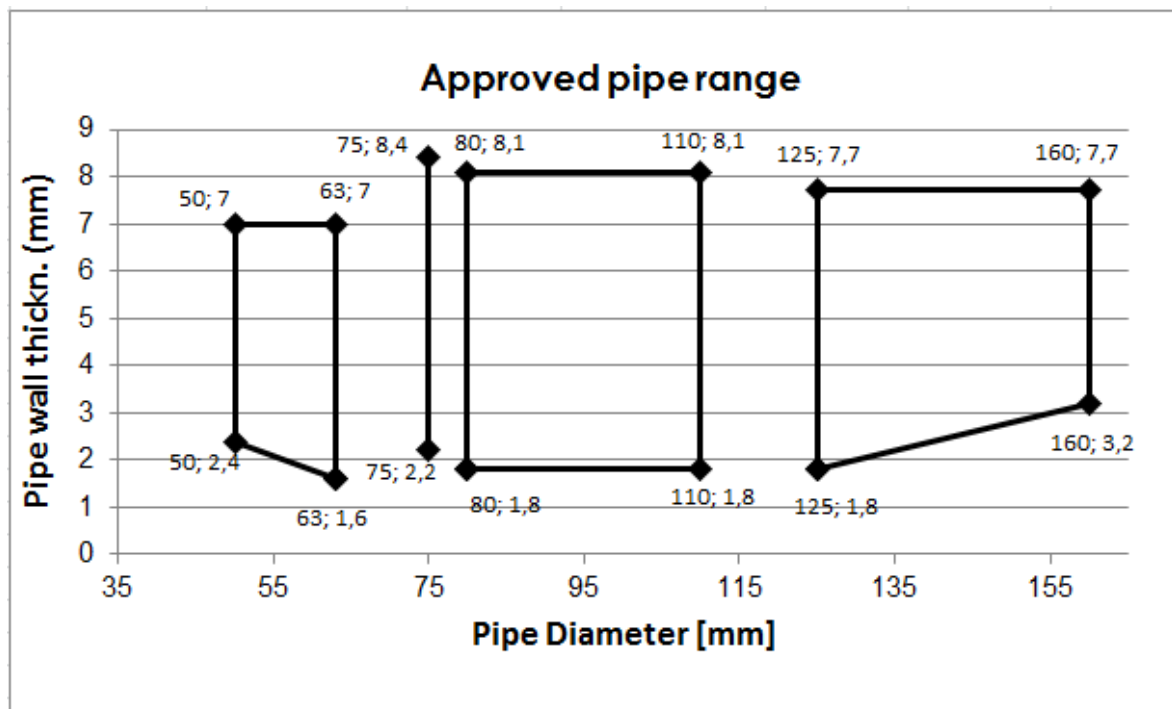
<sup>(1)</sup> interpolation of min. pipe wall thickness within pipe diameter range

**2.2.5 PP pipes according to EN 1451-1**

Designation: Cloes "Blue Power", Cloes "PhoNoFire", "Geberit Silent PP", Marley Silent, Ostendorf "Skolan-dB", Pipelife "Master 3", POLOPLAST "Polokal NG", "POLOPLAST Phonex AS", POLOPLAST "Polokal 3S", "POLOPLAST Polokal XS", Rehau "Raupiano Plus", Wavin "AS", KeKelit "Phonex AS", Wavin "SiTech", Valsire "Triplus", Valsire "Silere",

**Pipe end configuration: U/U****Distance of penetrations ( $s_1$ ): 0mm / 200 mm (B)**

Collar size ( $A_1$ )	Pipe diameter $d_c$ (mm)	Pipe wall thickness $t_c$ (mm)	Classification with Distance ( $s_1$ ) 0mm	Classification with Distance ( $s_1$ ) 200mm				
CFS-CID 50	40	1,8	EI 120-U/U	EI 180-U/U				
	50	1,8						
	58	4,0						
	<b>40 - 58</b>	<b>1,8 - 1,8/4,0<sup>(1)</sup></b>						
CFS-CID 75	50	1,8			EI 120-U/U	EI 180-U/U		
	75	3,8						
	<b>50 - 75</b>	<b>1,8/3,8<sup>(1)</sup></b>						
CFS-CID 110	90	2,2					EI 120-U/U	EI 180-U/U
	90	4,5						
	110	2,7						
	110	4,8						
	110	5,3						
	<b>90 - 110</b>	<b>2,2/2,7<sup>(1)</sup> - 5,3</b>						
CFS-CID 160	125	3,1	EI 120-U/U	EI 180-U/U				
	160	3,9						
	160	7,5						
	<b>125 - 160</b>	<b>3,1/3,9<sup>(1)</sup> - 7,5</b>						

<sup>(1)</sup> interpolation of min. pipe wall thickness within pipe diameter range

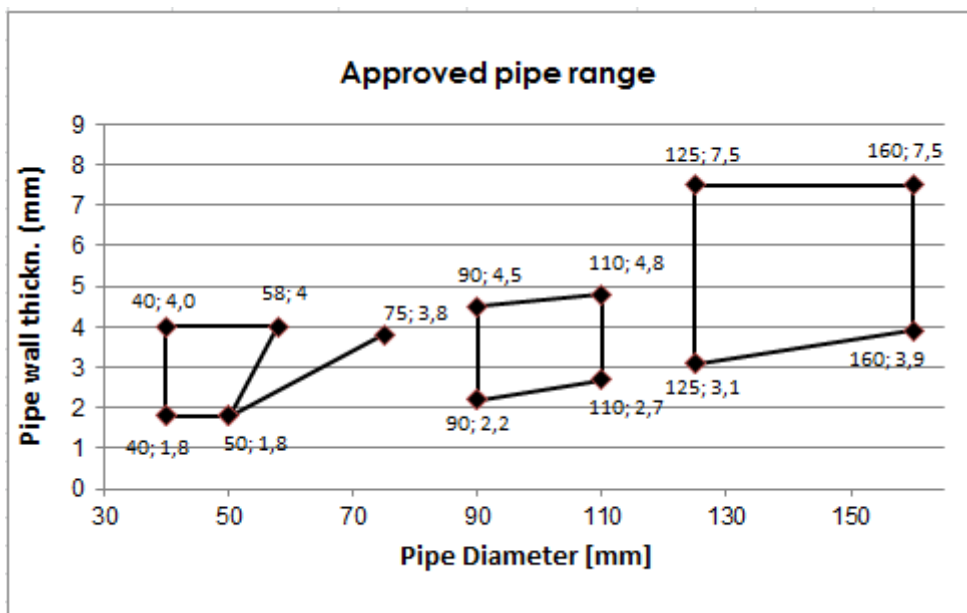

**2.2.6 PP-R pipes designation "Aquatherm"****Pipe end configuration: U/C****Distance of penetrations ( $s_1$ ): 200 mm (B)**

Collar size ( $A_1$ )	Pipe diameter $d_c$ (mm)	Pipe wall thickness $t_c$ (mm)	Classification with Distance ( $s_1$ ) 200mm
CFS-CID 50	32	2,9	EI 180-U/C
	50	4,6	
	63	5,8	
	<b>32 - 63</b>	<b>2,9/5,8</b> <sup>(1)</sup>	
CFS-CID 75	75	6,8	
	75	10,7	
	<b>75</b>	<b>6,8 - 10,7</b>	
CFS-CID 110	90	8,2	
CFS-CID 160	160	14,6	

<sup>(1)</sup> interpolation of min. pipe wall thickness within pipe diameter range

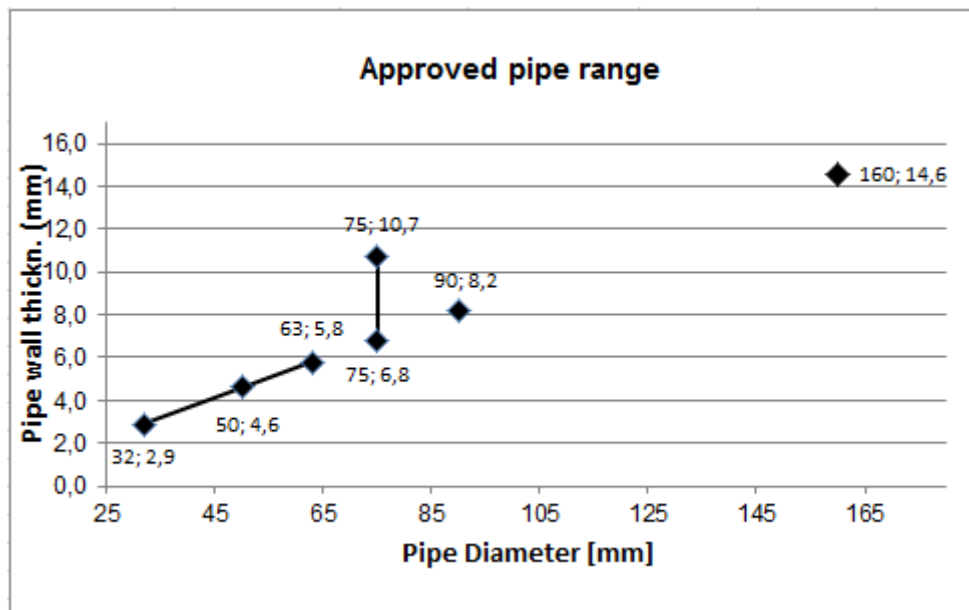

**2.2.7 PE-Xa pipes designation "Rehau Rautitan Flex"****Pipe end configuration: U/U****Distance of penetrations ( $s_1$ ): 200 mm (B)**

Collar size ( $A_1$ )	Pipe diameter $d_c$ (mm)	Pipe wall thickness $t_c$ (mm)	Classification with Distance ( $s_1$ ) 200mm
CFS-CID 50	32	4,0	EI 180-U/U
	50	6,9	
	63	8,6	
	<b>32 - 63</b>	<b>4,4/8,6</b> <sup>(1)</sup>	

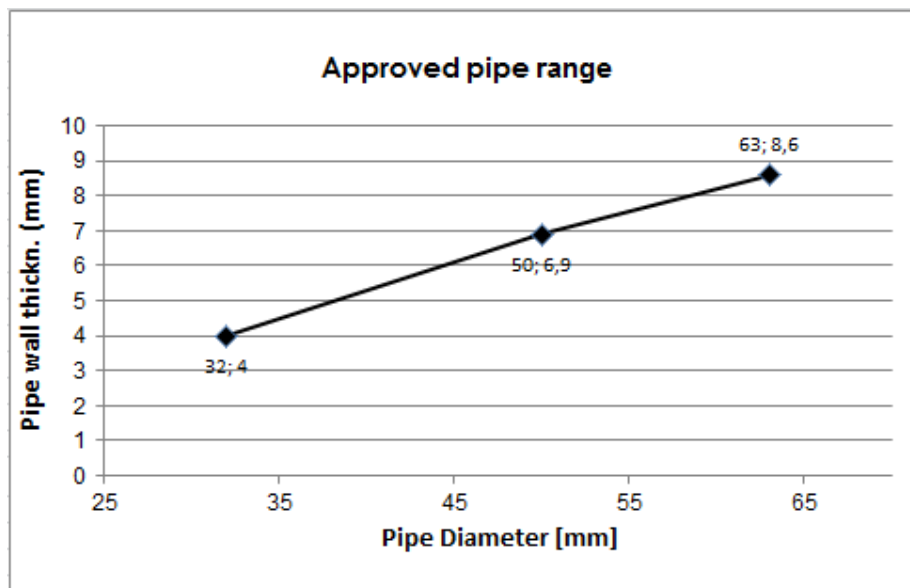
<sup>(1)</sup> interpolation of min. pipe wall thickness within pipe diameter range

**2.2.8 PE-X pipes designation "Geberit Mepla", elastomeric foamed thermal pipe insulation,  
Pipe end configuration: U/U  
Distance of penetrations ( $s_1$ ): 200 mm (B)**

Collar size ( $A_1$ )	Pipe diameter $d_c$ (mm)	Pipe wall thickness $t_c$ (mm)	Pipe insulation thickness (mm), CS	Classification with Distance ( $s_1$ ) 200mm
CFS-CID 50	40	3,5	9,0	EI 180-U/U

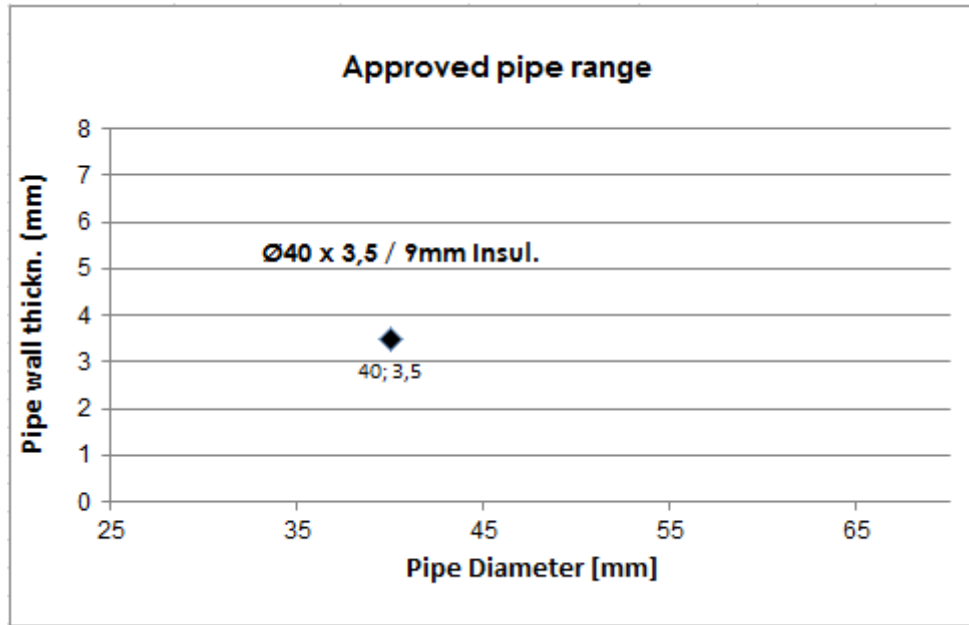

**2.2.9 Copper pipes including metal pipes, sustained (CS) elastomeric foamed thermal pipe insulation**

**Pipe end configuration: C/U**

**Distance of penetrations ( $s_1$ ): 200 mm (B)**

Collar size ( $A_1$ )	Pipe diameter $d_c$ (mm)	Pipe wall thickness $t_c$ (mm)	Pipe insulation thickness (mm)	Classification with Distance ( $s_1$ ) 200mm
CFS-CID 50	18	1,0	8,0	EI 180-C/U
	28	1,5	19,0	
CFS-CID 75	18	1,0	32,0	
CFS-CID 110	42	1,5	36,5	
	54	2,0	17,0	
CFS-CID 160	54	2,0	38,0	
	76	2,0	30,0	

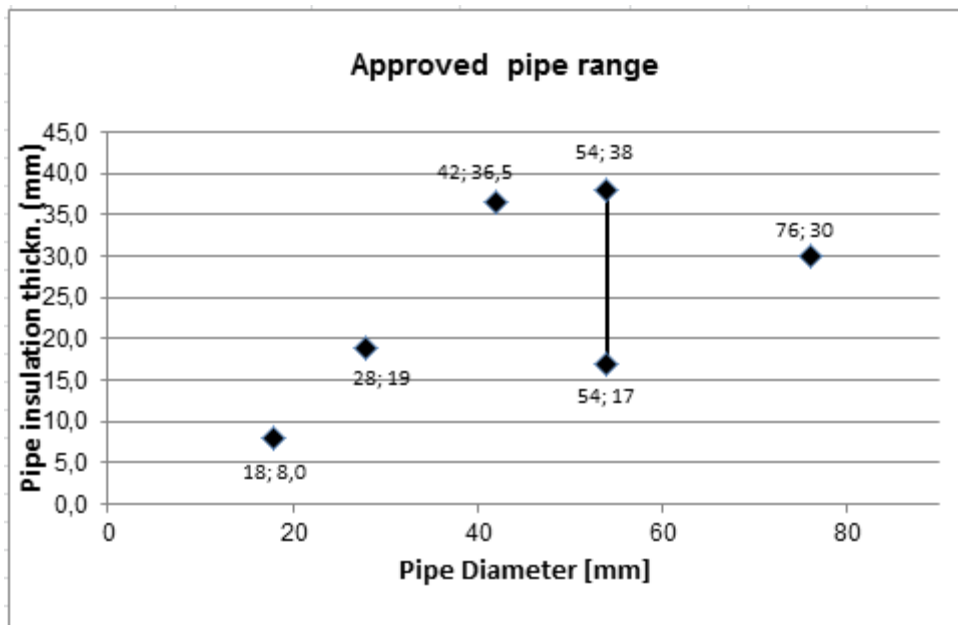



**2.2.10 Copper pipes including metal pipes,  
with sustained (CS) elastomeric foamed thermal pipe insulation  
Pipe end configuration: C/U  
Distance of penetrations ( $s_1$ ): 200 mm (B)**

Collar size ( $A_1$ )	Pipe diameter $d_c$ (mm)	Pipe wall thickness $t_c$ (mm)	Pipe insulation thickness (mm)	Classification with Distance ( $s_1$ ) 200mm
CFS-CID 50 CFS-CID 75 CFS-CID 110 CFS-CID 160	18 - 54	1,0/2,0 <sup>(1)</sup>	8,0 - 38,0 <sup>(3)</sup>	EI 120-C/U
	64 - 76	1,0/2,0 <sup>(1)</sup>	14,0 - 30,0 <sup>(3)</sup>	

<sup>(1)</sup> interpolation of min. pipe wall thickness within pipe diameter range

<sup>(3)</sup> interpolation of min. pipe insulation within pipe diameter range

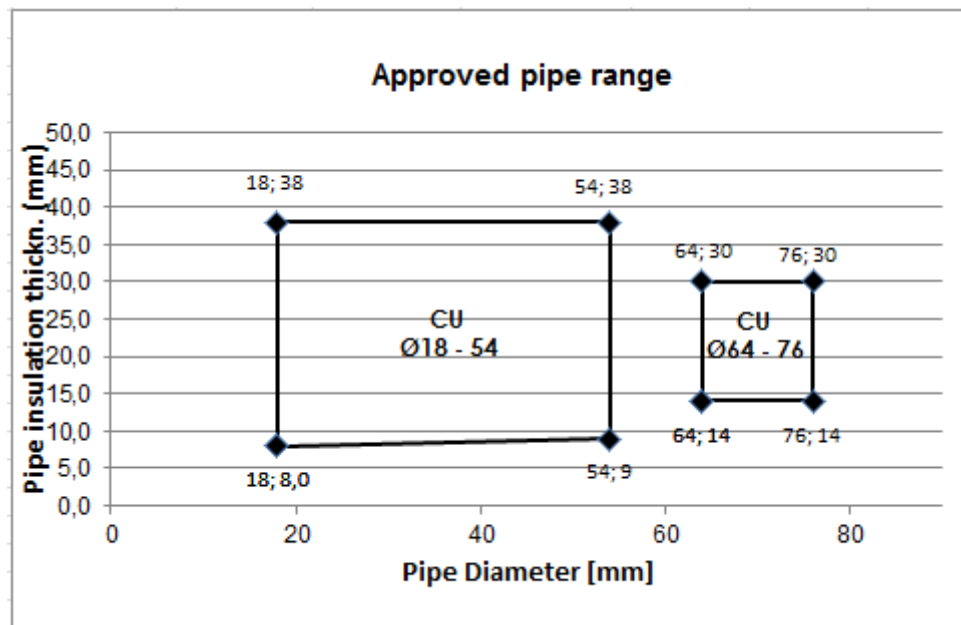

**2.2.11 Copper pipes including metal pipes,  
with local sustained (LS) mineral glass wool thermal pipe insulation  
Pipe end configuration: C/U  
Distance of penetrations ( $s_1$ ): 200 mm (B)**

Collar size ( $A_1$ )	Pipe diameter $d_c$ (mm)	Pipe wall thickness $t_c$ (mm)	Pipe insulation thickness (mm)	Classification with Distance ( $s_1$ ) 200mm
CFS-CID 50	18	1,0	20,0	EI 120-C/U
CFS-CID 75	35	1,5	20,0	
CFS-CID 110	76	2,0	20,0	

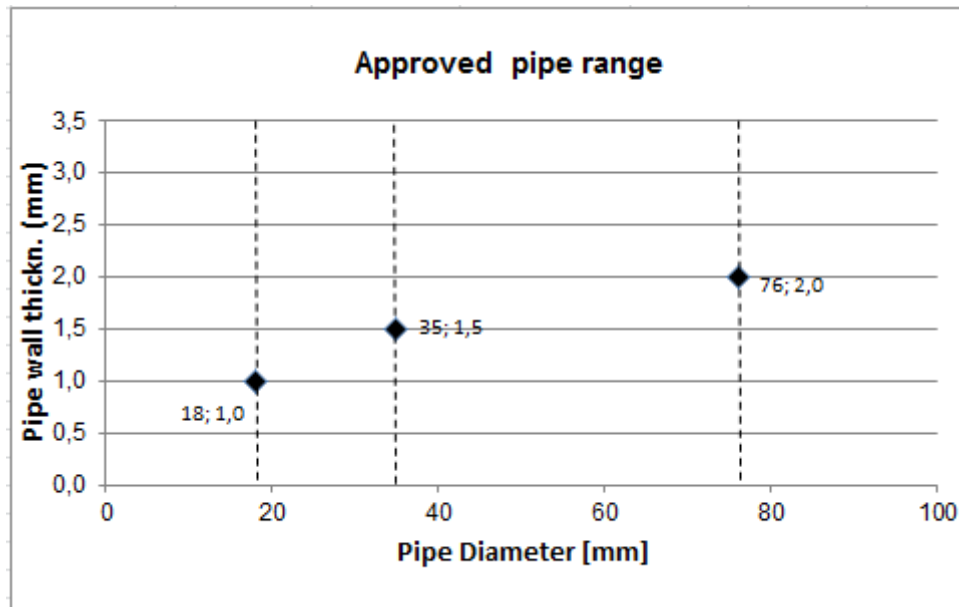

**2.2.12 Copper pipes including metal pipes,  
with local sustained (LS) mineral stone wool thermal pipe insulation  
Pipe end configuration: C/U  
Distance of penetrations ( $s_1$ ): 200 mm (B)**

Collar size ( $A_1$ )	Pipe diameter $d_c$ (mm)	Pipe wall thickness $t_c$ (mm)	Pipe insulation thickness (mm)	Classification with Distance ( $s_1$ ) 200mm
CFS-CID 50	18	1,0	20,0	EI 180-C/U
CFS-CID 75	35	1,5	20,0	
CFS-CID 110	76	2,0	20,0	
CFS-CID 160	89	2,0	20,0	

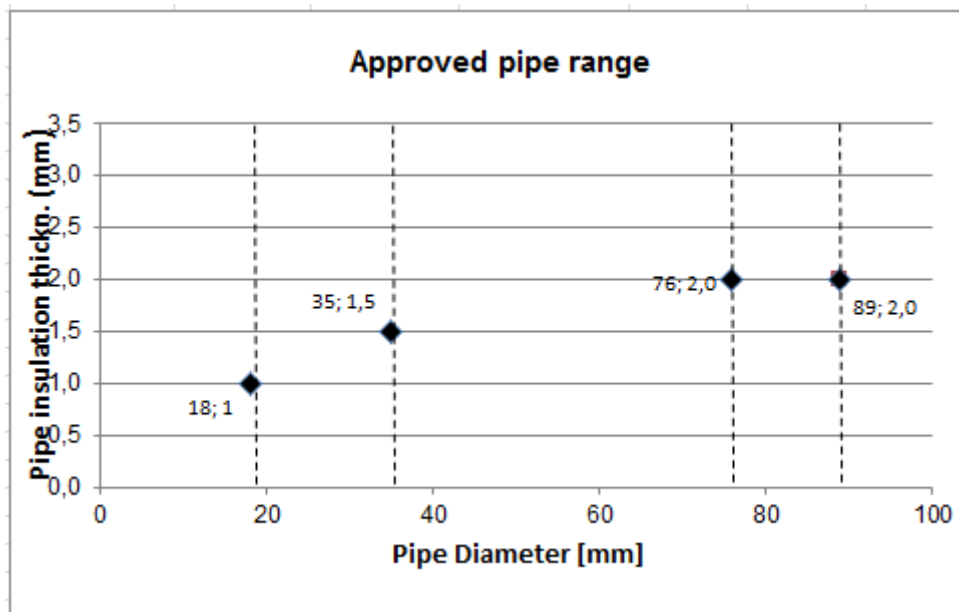

**2.2.13 PE pipes according to EN 1519-1, EN 12666-1, EN 12201-2 with 87° elbow,  
PVC pipes acc. to EN 1452-2, EN 1329-1, EN 1453-1 with 87° elbow  
Pipe end configuration: U/U  
Distance of penetrations (s<sub>1</sub>): 200 mm (B)**

Collar size (A <sub>1</sub> )	Pipe diameter d <sub>c</sub> (mm)	Pipe wall thickness t <sub>c</sub> (mm)	Classification with Distance (s <sub>1</sub> ) 200mm
CFS-CID 110	110	4,2	EI 180-U/U

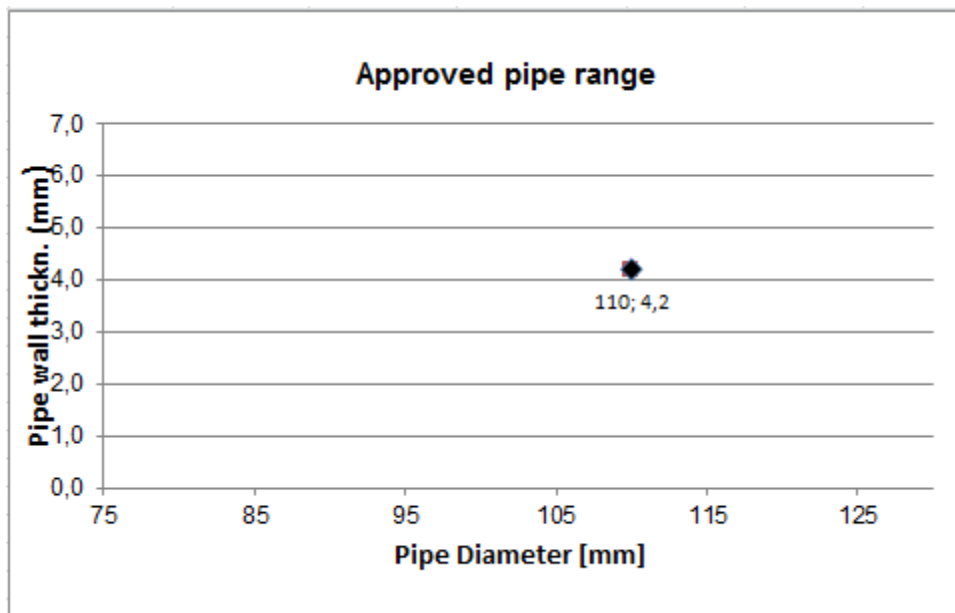

<b>2.2.14 Blank seals</b>		
<b>Distance of penetrations (<math>s_1</math>): 0mm / 200 mm (B)</b>		
Collar size ( $A_1$ )	Classification with Distance ( $s_1$ ) 0mm	Classification with Distance ( $s_1$ ) 200mm
<b>CFS-CID 50</b>	EI 120-U/U	EI 180-U/U
<b>CFS-CID 75</b>		
<b>CFS-CID 110</b>		
<b>CFS-CID 160</b>		

### 3.1 Penetrating services approved for CFS-CID with "Manifold"

The floor must have a minimum thickness of 150 mm and comprise concrete with a minimum density of 550 kg/m<sup>3</sup>.

#### Penetration seal:

- Pipes classified in the section 2.2.1 to 2.2.20 can be sealed with a Hilti Firestop Cast-in device CFS-CID with a Manifold adapter if the requirements of the options a) or b) given below are respected (the conditions to expose the intumescent layer of the Cast-in device to a potential fire have to be maintained):
  - a) the bottom side of the Cast-in device A<sub>1</sub> must be installed flush with the bottom side of the floor, the manifold A<sub>2</sub> is positioned on top of the Cast-in device
  - b) the bottom side of the manifold A<sub>2</sub> must be installed flush with the bottom side of the floor, the Cast-in device A<sub>1</sub> is positioned directly on top of the manifold
- the remaining floor thickness t<sub>E</sub> around the Cast-in device must be ≥150 mm

#### Manifold:

Option a)

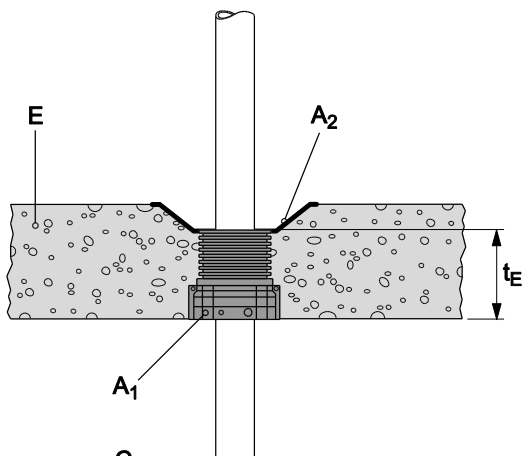

Option b)

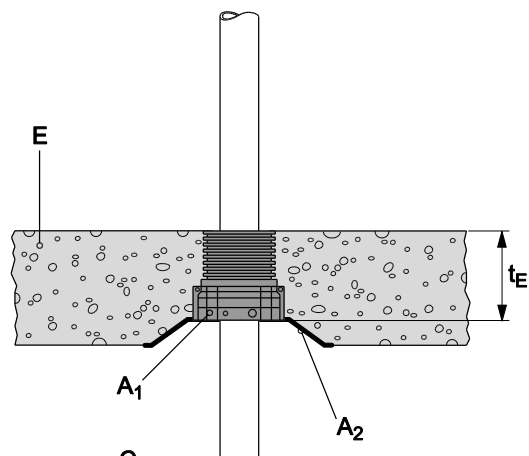

## ANNEX 3

### INSTALLATION OF THE PRODUCT AND ANCILLARY PRODUCT(S)

The arrangement and installation of Hilti Firestop Collar CFS-CID shall be done in accordance with the details given below and in Annex 2 for the penetration seal(s).

#### 3.1 CFS-CID installation

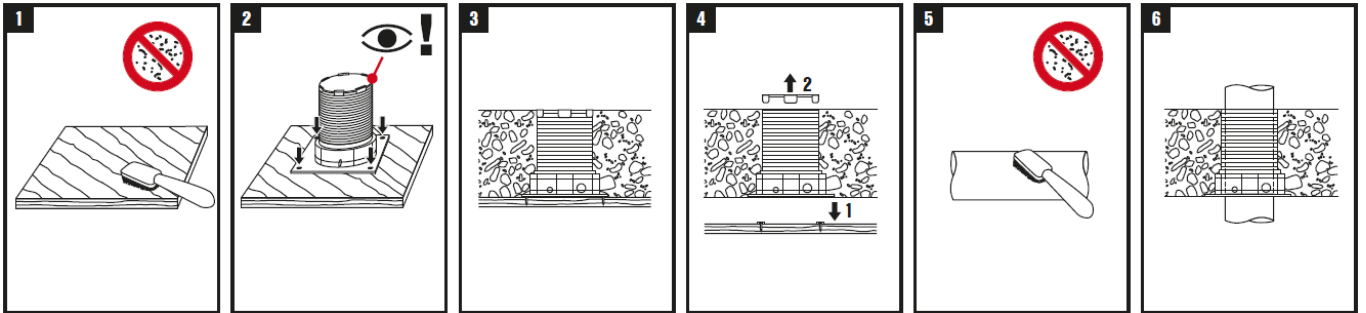

#### 3.2 Manifold installation

##### 3.2.1 CFS-CID with Manifold installed top side

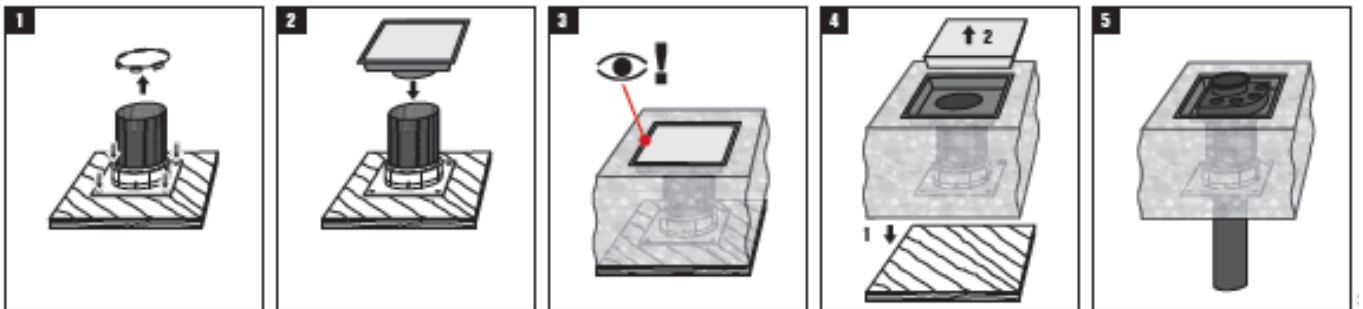

##### 3.2.2 CFS-CID with Manifold installed bottom side

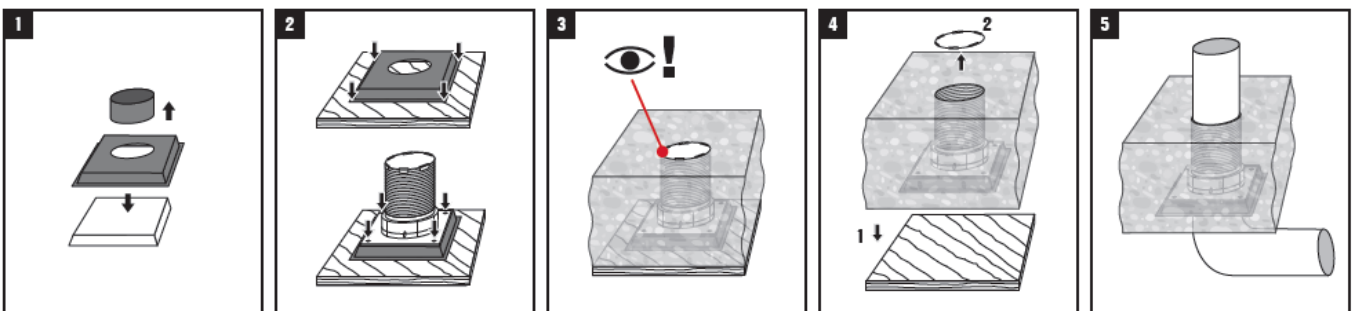

## ANNEX 4

### ABBREVIATIONS AND REFERENCE DOCUMENTS

#### 4.1 Abbreviations used in drawings

Abbreviation	Description
A <sub>1</sub>	Hilti Firestop Cast in CFS-CID
A <sub>2</sub>	Manifold
C	Plastic Pipe
D	Pipe insulation
d <sub>c</sub>	Pipe diameter (nominal outside diameter)
E	Building element (wall, floor)
s <sub>1</sub>	Minimum distance between single penetration seals
t <sub>c</sub>	Pipe wall thickness
t <sub>D</sub>	Insulation thickness
t <sub>E</sub>	Thickness of the building element
L <sub>D</sub>	Length of Insulation

#### 4.2 References to standards mentioned in the ETA:

EN 1026	Windows and doors – Air permeability – Test method
EN 1329-1	Plastics piping systems for soil and waste discharge (low and high temperature) within the building structure - Unplasticized poly(vinyl chloride) (PVC-U)
EN 1366-3	Fire resistance tests for service installations - Part 3: Penetration seals
EN 1451-1	Plastics piping systems for soil and waste discharge (low and high temperature) within the building structure - Polypropylene (PP) – Part 1: Specifications for pipes, fittings and the system
EN 1453-1	Plastics piping systems with structured-wall pipes for soil and waste discharge (low and high temperature) inside buildings - Unplasticized poly(vinyl chloride) (PVC-U)
EN 1519-1	Plastics piping systems for soil and waste discharge (low and high temperature) within the building structure - Polyethylene (PE) - Part 1: Specifications for pipes, fittings and the system
EN 1566-1	Plastics piping systems for soil and waste discharge (low and high temperature) within the building structure - Chlorinated poly(vinyl chloride) (PVC-C) - Part 1: Specifications for pipes, fittings and the system
EN 12201-2	Plastics piping systems for water supply, and for drainage and sewerage under pressure - Polyethylene (PE) - Part 2: Pipes
EN 12666-1	Plastics piping systems for non-pressure underground drainage and sewerage – Polyethylene (PE) – Part 1: Specifications for pipes, fittings and the system
EN 13501	Fire classification of construction products and building elements – Part 1: Classification using test data from reaction to fire tests Part 2: Classification using test data from fire resistance tests, excluding ventilation services
EN ISO 140-3	Acoustics – Measurement of sound insulation in buildings and of building elements – Part 3: Laboratory measurements of airborne sound insulation of building elements <sup>2</sup>

<sup>2</sup> In September 2010 substituted by the EN ISO 10140 series



EN ISO 717-1	Acoustics – Rating of sound insulation of buildings and of building elements – Part 1: Airborne sound insulation
EN ISO 1519	Paints and varnishes – Bend test (cylindrical mandrel)
EN ISO 1452	Plastics piping systems for water supply and for buried and above-ground drainage and sewerage under pressure - Unplasticized poly(vinyl chloride) (PVC-U) <sup>3</sup>
EN ISO 15493	Plastics piping systems for industrial applications - Acrylonitrile-butadiene-styrene (ABS), unplasticized poly(vinyl chloride) (PVC-U) and chlorinated poly(vinyl chloride) (PVC-C) - Specifications for components and the system; Metric series
EN ISO 15494	Plastics piping systems for industrial applications - Polybutene (PB), polyethylene (PE) and polypropylene (PP) - Specifications for components and the system; Metric series
EN ISO 15874	Plastics piping systems for hot and cold water installations - Polypropylene (PP)
EN ISO 20140-10	Acoustics – Measurements of sound insulation in buildings and of building elements – Part 10: Laboratory measurement of airborne sound insulation of small building elements <sup>2</sup>
DIN 8061	Unplasticized polyvinyl chloride (PVC-U) pipes - General quality requirements and testing
DIN 8062	Unplasticized polyvinyl chloride (PVC-U) pipes - Dimensions
DIN 8074	Polyethylene (PE) - Pipes PE 80, PE 100 - Dimensions
DIN 8075	Polyethylene (PE) pipes - PE 80, PE 100 - General quality requirements, testing
DIN 8077	Polypropylene (PP) pipes - PP-H, PP-B, PP-R, PP-RCT – Dimensions
DIN 8078	Polypropylene (PP) pipes - PP-H, PP-B, PP-R, PP-RCT - General quality requirements and testing
DIN 19531-10	Pipes and fittings made of unplasticized polyvinyl chloride (PVC-U) socket for waste and soil discharge systems inside buildings – Part 10: Fire behaviour, quality control and installation recommendations
DIN 19535-10	High-density polyethylene (PE-HD) pipes and fittings for hot-water resistant waste and soil discharge systems (HT) inside buildings – Part 10: Fire behaviour, quality control and installation recommendations

### 4.3 Other reference documents

EOTA TR 001	Determination of impact resistance of panels and panel assemblies
EOTA TR 024	Characterisation, Aspects of Durability and Factory Production Control for Reactive Materials, Components and Products

---

<sup>3</sup> Successor of EN 1452 since December 2009