



POS 150/180

English

Contents

1	Safety	5
1.1	General safety instructions, scanning tools	5
1.2	Battery use and care	6
1.3	Safety instructions, total station	6
1.4	Electromagnetic compatibility	7
2	Description	7
2.1	Intended use	7
2.2	Description of the tool	7
2.3	Declaration of conformity	8
2.4	Items supplied	8
3	Technical data	8
3.1	Telescope (POS 150/180)	8
3.2	Compensator (POS 150/180)	8
3.3	Angle measurement	9
3.4	Laser distance measurement / laser pointer (POS 150/180)	9
3.5	Measuring mode (prism, POS 150/180)	9
3.6	Measuring mode (reflectorless, POS 150/180)	9
3.7	Laser target tracking (POS 150/180)	9
3.8	Motorization (POS 150/180)	10
3.9	Wireless communication (between the POS 150/180 and POC 100/POC 200)	10
3.10	Interfaces (POC 100/POC 200)	10
3.11	Guide light (POS 150/180)	10
3.12	Laser plummet (POS 150/180)	10
3.13	Drives (POS 150/180)	10
3.14	IP protection class	10
3.15	Tripod thread	10
3.16	Temperature (POS 150/180, POC 100)	11
3.17	Temperature (POC 200)	11
3.18	Display	11
3.19	Power source	11
3.20	AC adapter	11
3.21	Charger	12
3.22	Battery	12
4	System description	12
4.1	General terms	12
4.1.1	Coordinates	12
4.1.2	Control lines	13
4.1.3	Tool axes	13
4.1.4	Telescope positions	13
4.1.5	Terms and their description	14
4.1.6	Abbreviations and their meaning	14
4.2	Angle measurement system	15
4.2.1	General points	15
4.2.2	Measuring principle	15
4.2.3	Dual-axis compensator	16

4.3	Distance measurement	17
4.3.1	Distance measurement	17
4.3.2	Targets	17
4.3.2.1	Prism targets	17
4.3.2.2	Reflector plates and reflective foil	18
4.3.2.3	Normal surfaces	18
4.3.3	Reflector rod	18
4.4	Height measurement	18
4.4.1	Height measurements	18
4.5	Guide light	19
4.5.1	Guide light	19
4.6	Laser pointer	19
4.7	Data points	19
4.7.1	Selecting points	20
5	First steps	21
5.1	Indicators and controls on the POC 100 controller touchscreen	21
5.2	Charging the battery	21
5.2.1	Charging the battery for the controller while still in the controller	21
5.2.2	Charging the battery for the total station	22
5.3	Removing and changing the battery	22
5.3.1	Changing the total station battery	22
5.3.2	Changing the controller battery	23
5.4	Setting up a radio connection	23
5.5	Checking functions	23
5.6	Controls and display screens	24
5.6.1	Control panel on the total station	24
5.6.2	Control panel on the controller	24
5.6.3	Status displays	25
5.7	Switching the controller on / off	26
5.7.1	Switching on	26
5.7.2	Switching off	26
5.8	Setting up the tool	26
5.8.1	Setting up over a mark on the floor or ground using the laser plummet	26
5.8.2	Setting up the tool	27
5.8.3	Setting up over a pipe using the laser plummet	28
6	System settings	28
6.1	Configuration	28
6.2	Settings	28
6.3	Calibrating the display	28
6.4	Time and date	29
6.5	In-the-field calibration	29
6.6	Hilti Repair Service	29
6.7	Prism settings	29
6.8	Search parameter settings	29
6.9	System information (I)	30
6.10	Settings for EDM and standard target	30
6.11	Function assignment for F1 and F2 buttons	30

7	Function menu (FNC)	31
7.1	Selecting the function	31
7.2	Guide light	32
7.3	Compensator	32
7.4	Laser pointer	33
7.5	Correction of atmospheric influences	33
7.6	EDM settings	33
7.7	Display illumination	33
7.8	Bubble level (compensator)	34
7.9	Help button	34
8	Functions for applications	34
8.1	Projects	34
8.1.1	Showing the active project	34
8.1.2	Selecting a project	35
8.1.3	Creating a new project	35
8.1.4	Project information	35
8.2	Setting a station and orientation	35
8.2.1	Overview	35
8.2.2	Setting the station over a point	36
8.2.3	Setting a station "anywhere"	38
8.2.4	Station with control line	42
8.2.4.1	Control line with 2 points	43
8.2.4.2	Control line with 3 points	44
8.2.5	Set station	46
8.2.6	Setting up the tool with height	47
9	Applications	48
9.1	Horizontal layout	48
9.1.1	Principle of the layout procedure	48
9.1.2	Setting out (layout) with prism	49
9.1.3	Procedure for "Layout with prism" application	49
9.1.4	Layout with visible laser (laser pointer)	53
9.1.5	Procedure for "Layout with visible laser" application	53
9.2	Measuring and recording	56
9.2.1	The principle of measure and record	56
9.2.2	Procedure for "Measure and record" application	57
9.3	Reference line	58
9.3.1	Principle of the reference line	58
9.3.2	Reference line with prism	59
9.3.2.1	Procedure for "Reference line with prism" application	59
9.3.3	Reference line with visible laser	62
9.3.4	Saving layout data	62
9.4	Check	63
9.4.1	The checking principle	63
9.4.2	Checking with the prism	63
9.4.2.1	Procedure for "Check with prism" application	63
9.5	Vertical layout (Vert. layout)	65
9.5.1	The vertical layout principle	65
9.5.2	Vertical layout with control lines	66
9.5.3	Vertical layout with coordinates	70

9.6	Smart Layout	72
9.6.1	Activating and starting the Smart Layout function	72
9.6.2	Smart Layout	74
9.7	Applications	74
9.7.1	Extracting points	75
9.7.1.1	Extracting / creating points	76
9.7.1.2	Creating offset points	77
9.7.1.3	Dividing a line or a segment of a line	77
9.7.1.4	Creating a point from a line intersection	77
9.7.2	Drawing	77
9.7.3	Carrying out calculations	77
9.7.3.1	Inverse	78
9.7.3.2	Offset	79
9.7.3.3	Intersection	80
9.7.3.4	Angle	81
9.7.3.5	Calculate area	82
9.7.4	Layer	83
9.7.5	Missing line	84
9.7.5.1	Procedure for “Missing line” application	86
9.7.6	The principle of area measurement	87
9.7.6.1	Procedure for “Area measurement” application	88
9.7.7	Theodolite	89
9.7.7.1	Zeroing the circle reading	89
9.7.7.2	Setting the horizontal circle display	90
9.7.7.3	Entering a circle reading manually	91
9.7.7.4	Inclination indicator	91
9.7.8	Indirect height measurement	92
9.7.8.1	The principle of indirect height measurement	92
9.7.8.2	Indirect height measurement	93
9.7.9	Vertical alignment	93
9.7.9.1	The principle of the vertical alignment mode	93
10	Data and data handling	95
10.1	Introduction	95
10.2	Point data	95
10.2.1	Points in the form of measured points	95
10.2.2	Points in the form of coordinate points	95
10.2.3	Points with graphical elements	96
10.3	Generation of point data	96
10.3.1	With the total station	96
10.3.2	With Hilti PROFIS Layout	96
10.3.3	With Hilti Point Creator	96
10.4	Data memory	97
10.4.1	Total station internal memory	97
10.4.2	USB mass storage device	97

11	Total station data manager	97
11.1	Overview	97
11.2	Procedure for “Data Manager” application	97
11.2.1	Import/Export Manager	98
11.2.1.1	Import points	98
11.2.1.2	Export points	100
11.2.1.3	Internal copying of data	100
11.2.1.4	Importing / attaching a .dxf or .dwg file	100
11.2.2	Project Manager	101
11.2.3	Point Manager	101
11.2.3.1	Fixed points	102
11.2.3.2	Measured points	102
11.2.3.3	Targeting	102
12	Data exchange	103
12.1	Introduction	103
12.2	Hilti PROFIS Layout	104
12.2.1	Data types	104
12.2.2	Hilti PROFIS Layout data output (export)	105
12.2.3	Hilti PROFIS Layout data input (import)	105
12.3	Hilti Point Creator	105
12.3.1	Overview of the functions available in Hilti Point Creator	106
13	Data connection with RS 232	107
14	Calibration and adjustment	107
14.1	Calibration review	107
14.2	Checking the laser point to the cross hairs	108
14.3	Procedure for “Calibration” application	108
14.3.1	Calibrating the tilt sensor	109
14.3.2	Calibrating the target axis error and VA collimation error	110
14.3.3	Calibrating the prism tracker	110
14.3.4	Hilti Repair Service	111
15	Care and maintenance	111
15.1	Cleaning and drying	111
15.2	Storage	111
15.3	Transport	112
16	Disposal	112
17	Manufacturer’s warranty	112
18	FCC statement / IC statement	112

1 Safety

1.1 General safety instructions, scanning tools

⚠ WARNING! Read all safety precautions and other instructions. Failure to observe the safety instructions and other instructions can result in electric shock, fire and/or serious injury.

Keep all safety precautions and instructions for future reference.

Work area safety

- ▶ **Keep your workplace clean and well lit.** Cluttered or poorly lit workplaces invite accidents.
- ▶ Do not operate the product in explosive atmospheres, such as in the presence of flammable liquids, gases or dust. Scanning tools create sparks which can ignite dust, fumes or vapors.
- ▶ **Keep children and other persons clear when the product is in use.** Distractions can cause you to lose control of the product.

Electrical safety

- ▶ Do not expose the product to rain or moisture. Water entering the product will increase the risk of electric shock.

Personal safety

- ▶ **Stay alert, watch what you are doing and use common sense when operating a scanning tool.** Do not use a scanning tool while you are tired or under the influence of drugs, alcohol or medication. A moment of inattention while operating the scanning tool can result in serious personal injury.
- ▶ **Adopt the correct posture when working. Maintain proper footing and balance at all times.** This will allow you to control the scanning tool better, even in unexpected situations.
- ▶ **Wear your personal protective equipment and always wear protective glasses.** Depending on the type of scanning tool you are using and its purpose, wearing safety equipment such as a dust mask, slip-resistant safety shoes, a hard hat or hearing protection will reduce the risk of injury.
- ▶ **Avoid starting the tool accidentally. Make sure that the scanning tool is switched off before connecting it to the battery and before picking it up or carrying it.** Carrying scanning tools with your finger on the switch or plugging in scanning tools that are already switched on can cause accidents.

Using and handling the scanning tool

- ▶ **Do not use a scanning tool if it has a faulty on/off switch.** A scanning tool that can no longer be switched on or off is dangerous and must be repaired.
- ▶ Store scanning tools out of reach of children when not in use. Do not allow persons who are not familiar with the product or these instructions to operate it. Scanning tools are dangerous in the hands of inexperienced persons.
- ▶ **Scanning tools need care and attention.** Check that moving parts operate satisfactorily and do not jam, and make sure that no parts are broken or damaged in such a way that the scanning tool might no longer function correctly. Have damaged parts repaired before using the scanning tool. Many accidents are caused by poorly maintained scanning tools.

Using and handling the cordless power tool

- ▶ **Use only the specified batteries in the scanning tools.** Use of other batteries can result in injury and a risk of fire.
- ▶ Recharge the batteries only with the chargers recommended by the manufacturer. A charger that is suitable for a certain type of battery can be a fire hazard if used with other batteries.
- ▶ **When the battery is not in use, keep it away from other metal objects such as paper clips, coins, keys, nails, screws, or other small metal objects that could cause bridging between the terminals.** A short circuit between the battery terminals may cause burns or a fire.
- ▶ **Liquid may leak from the battery if used incorrectly. Avoid contact with this liquid.** Liquid leaking from the battery may cause skin irritation or burns. If contact accidentally occurs, rinse with water. Seek medical attention if the liquid comes into contact with the eyes.

1.2 Battery use and care

- ▶ Observe the special regulations and instructions applicable to the transport, storage and use of Li-ion batteries.
- ▶ Do not expose batteries to high temperatures, direct sunlight or fire.
- ▶ Do not disassemble, crush or incinerate batteries and do not subject them to temperatures over 80 °C.
- ▶ Do not use or charge batteries that have suffered mechanical impact, have been dropped from a height or show signs of damage. In this case, always contact your **Hilti Service**.
- ▶ If the battery is too hot to touch it may be defective. In this case, place the product in a non-flammable location, well away from flammable materials, where it can be kept under observation and allowed to cool down. In this case, always contact your **Hilti Service**.

1.3 Safety instructions, total station

- ▶ Do not render safety devices ineffective and do not remove information and warning notices.
- ▶ If the product is opened improperly, laser radiation in excess of Class 2 may be emitted. **Have the product repaired by Hilti Service only.**
- ▶ Check that the product functions correctly each time before use.
- ▶ Measurements taken through panes of glass or other objects may be inaccurate.
- ▶ The measurement may be incorrect if the conditions under which the measurement is taken change rapidly, e.g. due to people walking through the path of the laser beam.
- ▶ Observe the information printed in the operating instructions concerning operation, care and maintenance.
- ▶ Do not use the product as a level.

- ▶ Do not point the product toward the sun or other powerful light sources.
- ▶ Although the product is designed for the tough conditions of construction site use, as with other measuring instruments it should be treated with care.
- ▶ Check the accuracy of the product after it has been dropped or subjected to other mechanical stresses.
- ▶ Secure the site at which you are taking measurements and take care to avoid directing the laser beam toward other persons or toward yourself.
- ▶ When the product is brought into a warm environment from very cold conditions, or vice-versa, allow it to become acclimatized before use.
- ▶ Keep the laser exit window clean in order to avoid measurement errors.
- ▶ Observe the accident prevention regulations applicable in your country.
- ▶ Use the product only within its specified limits.
- ▶ Precautions must be taken to ensure that the laser beam does not unintentionally strike highly reflective surfaces.
- ▶ Precautions must be taken to ensure that persons do not stare directly into the beam.
- ▶ The laser beam must not be allowed to project beyond the controlled area.
- ▶ Switch the laser tool off when it is not in use.
- ▶ When switching distance measurement from prism measurement to reflectorless measurement, make sure that you do not look at the objective lens of the tool.
- ▶ View the tool at an angle when setting it up with the aid of the circular bubble level.
- ▶ Laser beams should not be projected at eye height.
- ▶ The specified operating and storage temperatures must be observed.

1.4 Electromagnetic compatibility

Although the tool complies with the strict requirements of the applicable directives, **Hilti** cannot entirely rule out the possibility of interference to the tool caused by powerful electromagnetic radiation, possibly leading to incorrect operation. Check the accuracy of the tool by taking measurements by other means when working under such conditions or if you are unsure. Likewise, **Hilti** cannot rule out the possibility of interference with other devices (e.g. aircraft navigation equipment). The tool complies with the requirements of Class A; the possibility of interference occurring in a domestic environment cannot be excluded.

Only for Korea: This laser range meter is suitable for commercial and industrial use and for the electromagnetic radiation encountered in this field (Class A). Users must pay attention to this point and make sure that this laser range meter is not used in a domestic environment.

2 Description

2.1 Intended use

The tool is designed for measuring distances and directions, calculating target positions in three dimensions and the values derived from these positions and for laying out points using given coordinates or values relative to a control line. Observe the information printed in the operating instructions concerning operation, care and maintenance.

Take the influences of the surrounding area into account. Do not use the machine where there is a risk of fire and explosion.

Modification of the tool is not permitted.

2.2 Description of the tool

The **Hilti** POS 150/180 total station can be used to define objects as dynamic positions within a given space or area. The tool is equipped with horizontal and vertical circles with digital graduation, two electronic levels (compensators), a coaxial electronic distance meter (EDM) incorporated in the telescope and an electronic processor system for calculating and saving data.

The built-in target acquisition system allows prisms to be targeted automatically and their positions tracked even when they move. The prism's position is determined continuously and processed in the application on an ongoing basis. The total station is operated using the POC 100 or POC 200 controller.

Hilti PROFIS Layout, a PC application provided by Hilti, can be used to transfer data in both directions between the total station and a PC, for data processing and for exporting data to other systems. Data can also be transferred directly from the controller to a USB data storage device.

2.3 Declaration of conformity

We declare, on our sole responsibility, that the product described here complies with the applicable directives and standards. A copy of the declaration of conformity can be found at the end of this documentation.

The technical documentation is filed and stored here:

Hilti Entwicklungsgesellschaft mbH | Tool Certification | Hiltistraße 6 | 86916 Kaufering, DE

2.4 Items supplied

- 1 total station POS 150
- 1 **Hilti** total station toolbox POS 150 or POS 180
- 2 belt for the total station toolbox POA 65
- 1 manufacturer's certificate for POS 150/180
- 1 battery POA 84 for POS 150/180
- 1 AC adapter POA 85 for POS 150/180
- 1 charger POA 86 for POS 150/180
- 1 adjusting wrench POW 10
- 1 controller POC 100
- 1 manufacturer's certificate for POC 100
- 1 application software for the controller
- 1 battery POA 80 for POC 100
- 1 AC adapter POA 81 for POC 100
- 2 laser warning plate POAW 73
- 1 operating instructions
- 1 quick-start guide
- 1 testing plate POAW 82
- 1 rain cover POAW 81
- 1 **Hilti** accessory toolbox POA 100
- 1 360° prism POA 20
- 1 stylus POW 91
- 1 quick-release clamp POA 76
- 1 reflector rod POA 52
- 1 pouch POA 62

3 Technical data**3.1 Telescope (POS 150/180)**

Telescope magnification	31 x
Shortest target distance	1.5 m (4 ft - 11 in)
Telescope angle of view	1° 30'
Lens aperture	50 mm (2.0 in)
Minimum focus distance	1.5 m (4 ft - 11 in)

3.2 Compensator (POS 150/180)

Type	Dual-axis, liquid
Range, fine	± 5.5'
Range, coarse	± 3°
Accuracy	0.5"
Sensitivity to tribrach circular bubble level	± 8' / 2 mm

3.3 Angle measurement

POS 150 accuracy (DIN 18723)	5"
POS 180 accuracy (DIN 18723)	3"

3.4 Laser distance measurement / laser pointer (POS 150/180)

Wavelength	660 nm (0.0000260 in)
Laser class	3 R
Beam divergence	0.27 mrad
Maximum output power	< 5 mW

3.5 Measuring mode (prism, POS 150/180)

Laser class	3 R
Range (single prism)	1,000 m (3,280 ft - 10 in)
Accuracy (standard)	± 2 mm + 2 ppm (0.01 ft + 2 ppm)
Accuracy (tracking)	±5 mm + 2 ppm (0.02 ft + 2 ppm)
Measuring time (standard)	2.5 s
Measuring time (tracking)	0.5 s

3.6 Measuring mode (reflectorless, POS 150/180)

Laser class	3R
Range	KGC 90%: 600 m (1970 ft)
Range with reflective foil	800 m (2,624 ft - 10 in)
Accuracy (standard)	±3 mm + 2 ppm (0.1 ft + 2 ppm)
Accuracy (tracking)	±10 mm + 2 ppm (0.4 ft + 2 ppm)
Measuring time (standard)	3 s ... 10 s
Measuring time (standard)	0.7 s

3.7 Laser target tracking (POS 150/180)

Laser class	1
Maximum range	300 m (984 ft)
Pointing precision	< 2"
Search times (typical)	2 s ... 10 s
Beam divergence	40 x 30 mrad
Pulse duration	144 µs
Maximum pulse frequency	109 Hz
Maximum peak power	2.22 mW
Maximum average power	0.035 mW
Wavelength	850 nm

3.8 Motorization (POS 150/180)

Rotation speed	max. 90°/s
Telescope repositioning	4 s
Rotation 180° (typical)	3.5 s

3.9 Wireless communication (between the POS 150/180 and POC 100/POC 200)

Frequency range	2,400 MHz ...2,483.5 MHz
Maximum emitted transmission power	19.3 dBm
Range	300 m ...800 m (984 ft ...2,624 ft - 10 in)

3.10 Interfaces (POC 100/POC 200)

USB	External data connection
-----	--------------------------

3.11 Guide light (POS 150/180)

Aperture angle	8°
Light source	Red/green
Typical range	70 m (229 ft - 10 in)
Beam divergence	70 mrad
Maximum output power (red)	0.4 mW
Maximum output power (green)	0.2 mW
Wavelength (red)	645 Nm
Wavelength (green)	520 Nm

3.12 Laser plummet (POS 150/180)

Accuracy	1.5 mm at 1.5 m (1/16 in at 3 ft)
Maximum output power	< 5 mW
Wavelength	635 nm
Laser class	3R
Intensity levels	0 ...4
Beam divergence	0.6 mrad

3.13 Drives (POS 150/180)

Type (horizontal / vertical)	Motorized / continuous
Focus	Motorized

3.14 IP protection class

Tool (POS 150/180)	IP 55
Controller (POC 100)	IP 67
Controller (POC 200)	IP 65

3.15 Tripod thread

Tribrach thread	5/8"
-----------------	------

3.16 Temperature (POS 150/180, POC 100)

Operating temperature	-20 °C ... 50 °C (-4 °F ... 122 °F)
Storage temperature	-30 °C ... 70 °C (-22 °F ... 158 °F)

3.17 Temperature (POC 200)

Operating temperature	-30 °C ... 60 °C (-22 °F ... 140 °F)
Storage temperature	-40 °C ... 70 °C (-40 °F ... 158 °F)

3.18 Display

	POS 150/180	POC 100	POC 200
Display	Monochrome, 96 x 49 pixels	TFT color touchscreen, VGA 640 × 480 pixels	TFT capacitive color touchscreen, VGA 1024 × 600 pixels
Illumination	Backlit	5 levels	5 levels
Contrast	-	Day / night mode se- lectable	Day / night mode se- lectable
Control panel	3 buttons and on/off button	6 buttons and on/off button	6 buttons and on/off button

3.19 Power source

	POS 150/180	POC 100	POC 200
AC adapter	POA 85	POA 81	POA 89
Battery	POA 84	POA 80	POA 90
External	POA 88 to 12 V	-	-

3.20 AC adapter

	POS 150/180	POC 100	POC 200
AC adapter	POA 85	POA 81 (US: TR30RAM0) for the POA 80 battery	POA 89
Supply voltage	100 V ...240 V	100 V ...240 V	100 V ...240 V
AC frequency	50 Hz ...60 Hz	50 Hz ...60 Hz	50 Hz ...60 Hz
Current input	-	0.4 A ...0.8 A	1.5 A
Power input	100 VA	-	-
Output current	3 A	4 A	5 A
Output voltage (DC)	19 V	5 V	12 V
Weight	0.32 kg (0.71 lb)	0.25 kg (0.55 lb)	0.33 kg (0.73 lb)
Operating temperature	-20 °C ...40 °C (-4 °F ...104 °F)	-20 °C ...40 °C (-4 °F ...104 °F)	-20 °C ...40 °C (-4 °F ...104 °F)
Storage temperature	-30 °C ...70 °C (-22 °F ...158 °F)	-30 °C ...70 °C (-22 °F ...158 °F)	-30 °C ...70 °C (-22 °F ...158 °F)

3.21 Charger

POS 150/180	
Type	POA 86 for the POA 84 battery (POA 86 supplied by POA 85 AC adapter)
Supply voltage (DC)	19 V
Output current	3 A
Output voltage (DC)	10 V ...21 V
Weight	0.18 kg (0.40 lb)
Operating temperature	-20 °C ...40 °C (-4 °F ... 104 °F)
Storage temperature	-30 °C ...70 °C (-22 °F ... 158 °F)

3.22 Battery

	POS 150/180	POC 100	POC 200
Type	POA 84, Li-ion; charging with battery charger POA 86	POA 80, Li-ion; charging directly in POC 100	POA 90, Li-ion; charging directly in POC 200
Rated voltage	11.1 V	3.8 V	7.5 V
Battery capacity	5,000 mAh	5,200 mAh	6,000 mAh
Battery life	at 25 °C: 6 hours	at 25 °C: 10 hours	at 25 °C: 16 hours
Charging time	< 4 hours	<3 hours	< 3 hours
Operating temperature	-20 °C ...45 °C (-4 °F ... 113 °F)	-20 °C ...50 °C (-4 °F ... 122 °F)	-30 °C ...60 °C (-22 °F ... 140 °F)
Storage temperature	-30 °C ...70 °C (-22 °F ... 158 °F)	-30 °C ...70 °C (-22 °F ... 158 °F)	-30 °C ...70 °C (-22 °F ... 158 °F)

4 System description

4.1 General terms

4.1.1 Coordinates

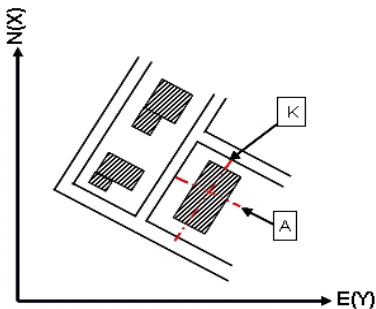

On some construction sites, instead of or in combination with control lines, additional points are marked out and their positions described by coordinates.

The coordinates used are generally based on the national coordinate system which is also usually taken as a basis for maps of the country.

4.1.2 Control lines

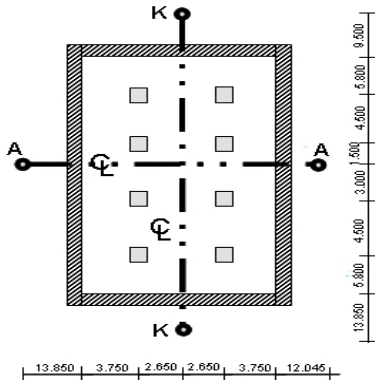

Height marks and control lines are generally marked out on and around the building plot by a surveyor before construction begins.

Two ends are marked on the ground for each control line.

These marks are used to position the individual components of the building or structure. Large buildings require a number of control lines.

4.1.3 Tool axes

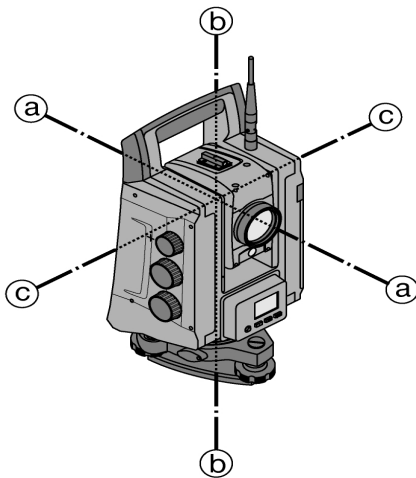

a: Target axis

b: Vertical axis

c: Tilt axis

4.1.4 Telescope positions

The term “telescope position” is used to ensure that readings from the horizontal circle can be correctly assigned to the vertical angle, i.e. the position of the telescope relative to the control panel determines in which “position” the measurements have been taken.

When the display and the eyepiece are immediately in front of you, then the tool is in telescope position 1.

When the display and the objective lens are immediately in front of you, then the tool is in telescope position 2.

4.1.5 Terms and their description

Target axis	The line through the cross hairs and center of the objective lens (telescope axis)
Tilt axis	Telescope tilt axis
Vertical axis	Tilt axis of the entire tool
Zenith	Upwards direction of gravity
Horizon	Direction perpendicular to the direction of gravity
Nadir	Downwards direction of gravity
Vertical circle	Circle of angles, the values of which change when it is being moved upwards or downwards
Vertical direction	Reading taken from the vertical circle
Vertical angle (VA)	A vertical angle is a reading from the vertical circle. The vertical circle is usually aligned with the direction of gravity with the aid of the compensator, with the zero point at the zenith.
Elevation angle	An elevation angle of zero refers to the horizon (horizontal plane). Positive angles are above horizontal (upwards) and negative angles are below horizontal (downwards).
Horizontal circle	Circle of angles, the values of which change when the tool is turned
Horizontal direction	Reading taken from the horizontal circle
Horizontal angle (HA)	A horizontal angle is the difference between two readings from the horizontal circle. However, a reading from one of the circles is also often described as an angle.
Slope distance (SD)	Distance from the center of the telescope to the point at which the laser beam strikes the target surface
Horizontal distance (HD)	The horizontal distance derived from the measured slope distance
Alidade	The rotatable center part of the total station is known as the alidade. This part usually carries the control panel, bubble levels for leveling and, inside, the horizontal circle.
Tribrach	The tool stands on the tribrach which, for example, can be mounted on a tripod. The tribrach has three points of contact which can be adjusted vertically by adjusting screws.
Tool station	This is the location at which the tool is set up – usually over a point marked on the ground.
Station height (Stat H)	The height of the point on the ground at the tool station (above a reference height).
Tool height (HI)	The height from the point on the floor or ground to the center of the telescope
Reflector height (HR)	Distance from the center of the reflector to the tip of the reflector rod
Orientation (backsight) point	The target point used in conjunction with the tool station to determine the horizontal reference direction for the horizontal angle measurement
Coordinate easting (Y) or ordinate	In a typical surveying coordinate system, this value refers to the east-west direction.
Coordinate northing (X)	In a typical surveying coordinate system, this value refers to the north-south direction.
Line (L)	Designation for a linear dimension along a control line
Offset (O)	Designation for a distance at right angles to a control line or other reference line
Height (H)	Vertical distance from a reference point or reference surface

4.1.6 Abbreviations and their meaning

EDM	Electronic laser distance meter
HA	Horizontal angle

VA	Vertical angle
dHA	Delta horizontal angle
dVA	Delta vertical angle
SD	Slope distance
HD	Horizontal distance
dHD	Delta horizontal distance
HI	Tool height
HR	Reflector height
Ref. height	Reference height
Stat H	Station height
h	Height
E	East
N	North
Offset	Offset
I	Line value
dH	Delta height
dE	Delta east
dN	Delta north coordinate
dOffs	Delta offset horz
dL	Delta long

4.2 Angle measurement system

4.2.1 General points

The vertical and horizontal circle readings are taken using diametrical “absolute measuring taps”. Horizontal circle readings are corrected by instrumental errors such as tipping axis errors, target axis errors and standing axis tilt. Vertical circle readings are corrected by VA collimation and standing axis tilt.

4.2.2 Measuring principle

The tool calculates the angle in each case from two circle readings.

For the purpose of distance measurement, pulses transmitted along a visible laser beam at a certain wavelength are reflected from the object to which the measurement is being taken.

Distances can be determined from the values obtained from these pulses.

Tool inclination is determined with the aid of electronic levels (compensators), circle readings are corrected accordingly and the height difference is also calculated from the measured slope distance and horizontal distance.

With the aid of a built-in microprocessor, all distance units, e.g. metric meters and imperial system feet, yards, inches, etc., can be converted. Digital circle graduation allows various angle units to be shown, e.g. 360° sexagesimal graduation (° ' ") or gon (g), whereby the full circle consists of 400 g graduations.

4.2.3 Dual-axis compensator

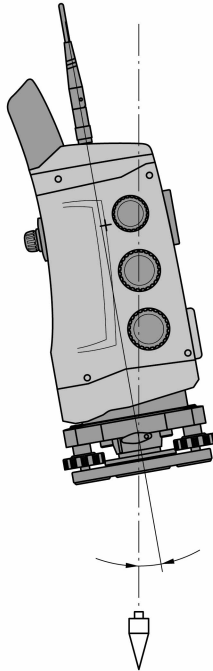

A compensator is, in principle, an electronic leveling system that determines exactly the remaining inclination of the axes of the total station after it has been set up.

If the corresponding axes of the total station are not vertical or horizontal, more or less serious errors will be caused in the angle measurements, depending on the tool tilt.

The dual-axis compensator determines this remaining inclination of the tool with great accuracy in the line and offset axes.

All calculations are then corrected automatically to ensure that this remaining inclination has no influence on angle measurements.

4.3 Distance measurement

4.3.1 Distance measurement

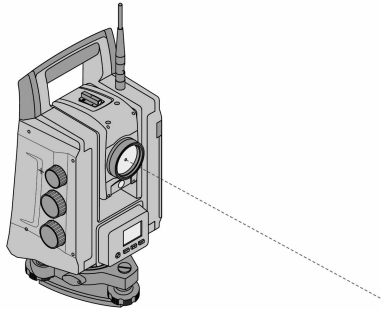

i Distance measurement, accuracy and the time required to take a measurement depend on the angle of the laser beam to the target, the material from which the target is made, the reflectivity of the target and the ambient conditions.

Distance measurement is by way of a visible laser beam emitted through the center of the objective lens, i.e. the laser distance meter is coaxial.

The laser beam takes measurements on normal surfaces without need for a special reflector.

Normal surfaces are considered to be those that are not highly reflective. These surfaces may have a rough texture.

The range depends on the reflectivity of the target surface, i.e. only slightly reflective surfaces such as those with a blue, red or green color may reduce the effective range.

The tool is supplied complete with a reflector rod to which an adhesive reflective foil is attached.

Taking readings from this reflective foil ensures reliable distance measurements even at long range.

The reflector rod also allows distance measurements to be taken to points marked on the ground.

i Check at regular intervals to ensure that the visible laser distance meter beam is correctly adjusted and in line with the sighting axis. Please contact your local **Hilti** Service Center if adjustment is necessary or if you are unsure.

4.3.2 Targets

4.3.2.1 Prism targets

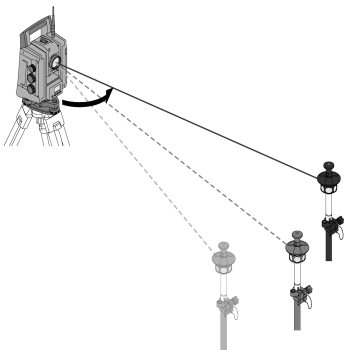

Prisms can be used for distance measurements as well as target tracking.

Target tracking works efficiently with 360° prisms as alignment of the prism is not required and the operator can therefore concentrate on the measurement task at hand.

i Prisms always have a prism constant in relation to the inner optical path. To measure reliable distances and/or target point positions, care must be taken to ensure that the correct prism with the correct prism constant is selected and used.

4.3.2 Reflector plates and reflective foil

The tool can be used to take reliable distance measurements from reflector plates equipped with reflective foil or from special adhesive reflective foil at distances of up to about 300 m, provided the laser beam strikes the reflective foil at right angles.

4.3.2.3 Normal surfaces

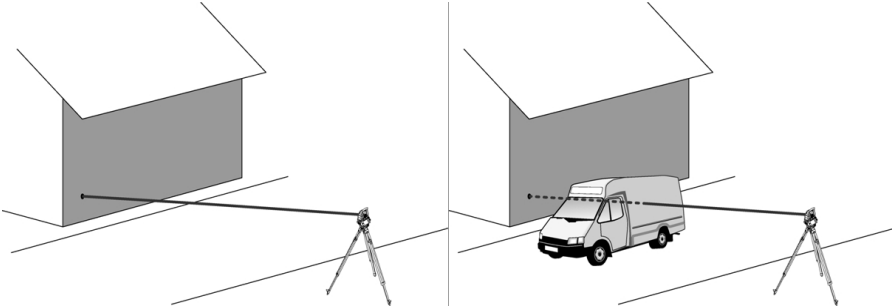

The laser beam takes measurements on normal surfaces such as concrete walls without need for a special reflector. Normal surfaces are considered to be those that are not highly reflective. These surfaces may have a rough texture. The range depends on the reflectivity of the target surface, i.e. only slightly reflective surfaces such as those with a blue, red or green color may reduce the effective range.

The laser beam is capable of measuring to any stationary target. While a distance is being measured, care must be taken to ensure that no other object is located in the laser beam.

4.3.3 Reflector rod

Reflector rods are used to measure to points on the ground.

The reflector rods are equipped either with a reflector and reflective foil or with a prism and often have a scale for the reflector height.

4.4 Height measurement

4.4.1 Height measurements

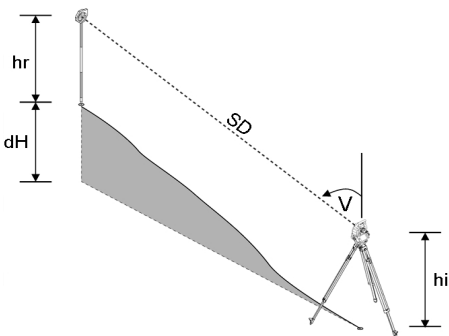

The tool can be used to measure heights or differences in height.

Height measurements are made using the trigonometrical height measurement principle and are calculated accordingly.

The height measurements take the vertical angle and the slope distance in conjunction with the tool height and the reflector height into account:

$$dH = \cos(V) \cdot SD + hi + hr + (korr)$$

In order to calculate the absolute height of the target point (point on the ground), the station height (Stat H) is added to the delta height:

$$H = Stat H + dH$$

4.5 Guide light

4.5.1 Guide light



The guide light comprises an exit aperture on the telescope, half of which emits green and half red light. There are four setting options:

- Off
- Flashing frequency – slow
- Flashing frequency – fast
- Flashing frequency – auto: This flashing only appears if the connection to the prism is lost.

In the activated state, a person can see either the green or the red light, depending on which side of the sighting line the person is located.

A person is in the sighting line if both colors can be seen at the same time.

4.6 Laser pointer

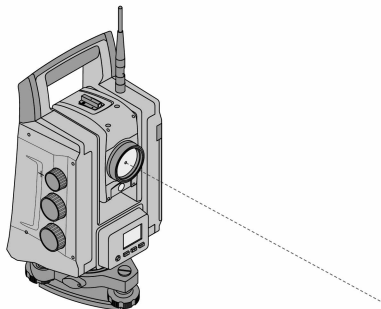

The tool is equipped with an EDM with various settings, depending on the objective. With the **Reflectorless measuring (RL)** EDM setting, the visible laser beam can be switched on permanently (laser pointer).

The laser pointer can be used indoors as a visible measuring and layout point.

4.7 Data points

The data from measurements taken with a **Hilti** total station is used to generate measured points.

Similarly, these measured points and their position descriptions are used in applications such as “Layout” or to define station locations.

Hilti total stations incorporate various features that facilitate and speed up the process of selecting points.

4.7.1 Selecting points

Point selection forms an important integral part of a total station system as points are generally measured and used repeatedly for laying out, for stations, as orientation aids and for comparative measurements.

Options for point selection:

- From a plan
- From a list
- By manual entry

To select points from a plan:

- Control points (fixed points) are available for selection in graphical form.

Selecting points from a list

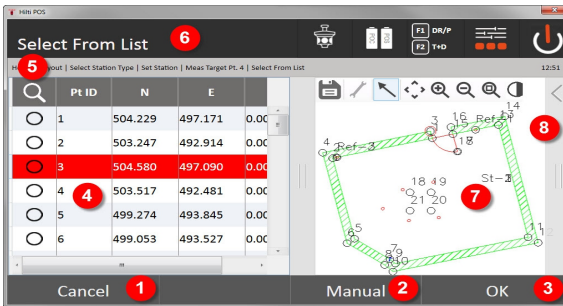

1. Return to point entry
2. Enter point manually
3. Confirm point selection
4. Select the point from a list
5. Point search
6. Title bar
7. Select the point from a plan
8. Toolbar

Entering points manually

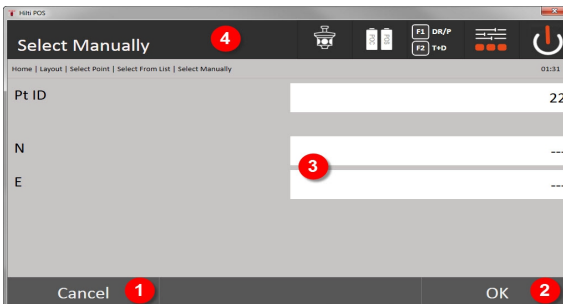

9. Cancel the function
10. Select points
11. Enter the point coordinates
12. Title bar

5 First steps

5.1 Indicators and controls on the POC 100 controller touchscreen

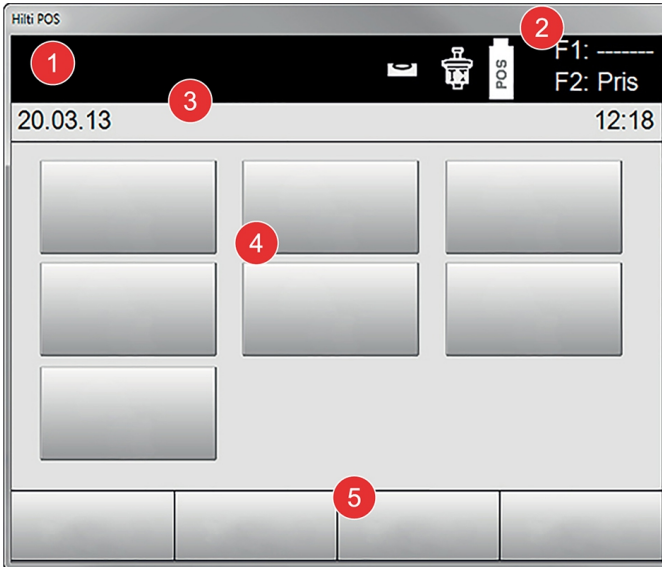

1. Information bar
2. Battery status, wireless connection and measuring target status
3. Menu display (action, time and date)
4. Various applications
5. Button bar

5.2 Charging the battery

5.2.1 Charging the battery for the controller while still in the controller

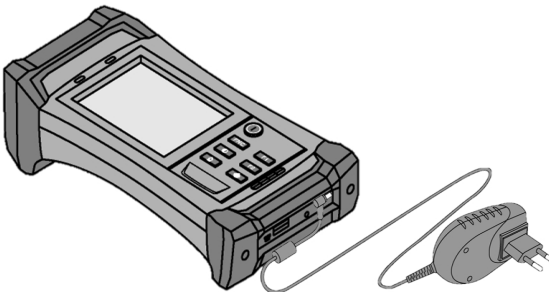

1. Insert the battery in the controller.
2. Connect the AC adapter to the controller.
 - ◀ The charging control lamp on the controller lights up green when the charging operation is complete.

5.2.2 Charging the battery for the total station

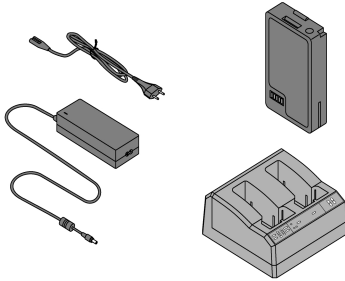

1. Connect the AC adapter to the battery charger.
2. Insert the battery in the charger.
 - ◀ The green LED flashes on the battery charger when the battery is being charged.
 - ◀ When the battery is charged, the green LED on the battery charger lights up permanently.

5.3 Removing and changing the battery

5.3.1 Changing the total station battery

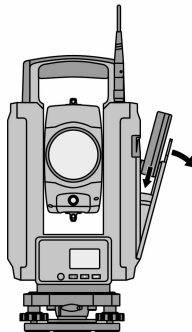

1. Open the battery cover with the pushbutton.



In order to ensure that all settings remain saved in the total station, the new battery must be inserted within 90 seconds of removing the previously used battery.

2. Push the battery, with the pushbutton facing upwards, into the battery holder on the inside of the battery compartment cover so that the contacts are facing the tool and the check button on the battery is facing upwards.

5.3.2 Changing the controller battery

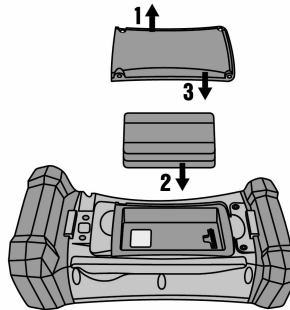

1. Undo the screws on the battery compartment.
2. Remove the battery cover.
3. Remove the battery.
4. Insert the battery in the battery compartment with the contacts facing downwards.
5. Fit the battery cover.
6. Replace and tighten the screws.

5.4 Setting up a radio connection

1. Switch on the total station and controller.

i The total station can only be operated using the controller. It is therefore essential that a radio connection be established between the controller and the total station.

2. Start the **Hilti** application via **Start / Programs** on the controller.
3. Level the total station on a stable surface or tripod using the displayed electronic bubble level.
4. In the menu, select the **Radio Channel** option, then use the arrow button to select the required channel.
5. On the controller, press the **Radio** button in the first dialog to make the necessary connection settings.
6. Select the same radio channel on the controller as on the total station.
 - ◀ A connection should be established in no more than 2 minutes.
 - ◀ The controller indicates that a connection has been established by displaying two batteries and the total station by showing the **Connected** status message.
7. Make sure that the radio signal is activated on the controller and that the same radio channel is selected for both devices.
8. If a radio connection cannot be established after several attempts, switch both devices off and start again.

5.5 Checking functions

The horizontal, vertical and focus drives function as motorized endless drives.

i Please note that this tool makes use of friction clutches for pivoting about the alidade and thus does not have to be locked at the horizontal drives.

5.6 Controls and display screens

5.6.1 Control panel on the total station

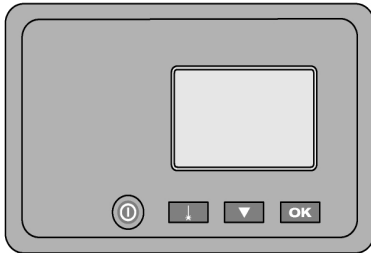

The control panel comprises a 5-line display and four buttons. This control unit is used to make basic settings on the total station.

Function buttons on the total station → page 24

Function buttons on the total station

	Switches the tool on or off
	Laser plummet on / off
	Shifts focus downwards, rolling
	Confirms the selected display.

5.6.2 Control panel on the controller





The control panel on the controller consists of a total of 7 buttons with symbols plus a touch screen for interactive operation.

Function buttons on the controller → page 25

Function buttons on the controller

	Switches the tool on or off
	Switches the display backlight on or off
	Calls up the FNC menu for additional settings
	Cancels or ends all active functions and returns to the start menu
	User-configured function button
	User-configured function button
	Control and prism search function button

5.6.3 Status displays

Important tool status information is displayed in the top right-hand corner of the screen.

Status indicator → page 25

Status indicator

	Compensator on / off
	EDM Active target Type Setting including status laser pointer and the laser plummet
	Battery state of charge: 0 - 100%

5.7 Switching the controller on / off

5.7.1 Switching on

To switch on, press the on / off button briefly.

 If the tool has been fully switched off, the complete start-up procedure takes approx. 20 - 30 seconds. Two different displays appear one after the other.

The end of the start-up process is reached when the tool has to be leveled.

To switch off, press and hold down the on / off button for approx. 2 seconds (2 short acoustic signals), then release the button.

5.7.2 Switching off

 Note that when switching off or restarting, the user is asked to confirm this action, just to be sure.

Press the on / off button.

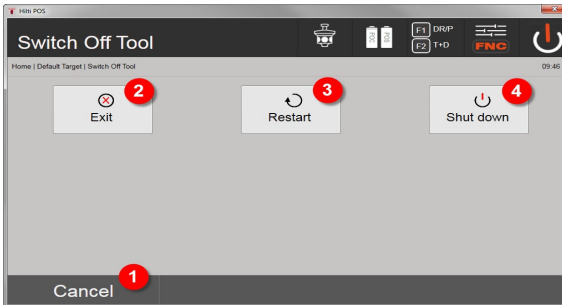

1. Cancel and return to previous screen
2. **Hilti** application is closed, controller remains switched on
3. Restart the controller
Any data not already saved will be lost.
4. Switch off the controller completely

5.8 Setting up the tool

5.8.1 Setting up over a mark on the floor or ground using the laser plummet

The tool should always be set up over a point marked on the floor or ground so that in case of measurement deviations it is possible to fall back on the data for the station or orientation point.

The tool features a laser plummet that is switched on automatically together with the tool.

5.8.2 Setting up the tool

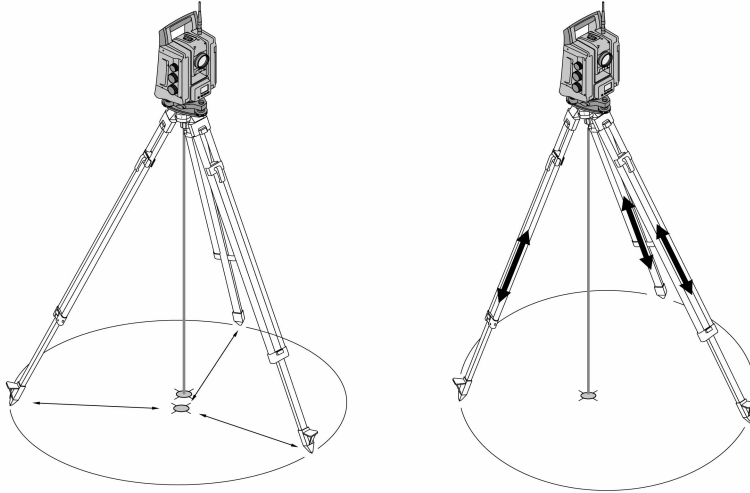

1. Set up the tripod with the middle of the tripod head roughly over the point on the floor or ground.
2. Screw the tool to the tripod, switch off the tool and switch on the laser plummet.
3. Move two of the tripod legs until the laser beam strikes the mark on the floor or ground.



Take care to ensure that the tripod head remains approximately horizontal.

4. Press the tripod legs into the ground using your feet.
5. Adjust the footscrews so that the remaining deviation from the laser point to the marking on the floor or ground disappears. The laser point must now be exactly on the center of the mark on the floor or ground.
6. Extend the legs of the tripod and move them so that the circular bubble level on the tribrach is in the middle.



This is done by extending or retracting the leg at the opposite side of the tripod, depending on the direction in which the bubble is to be moved. This process may have to be repeated several times until the desired result is achieved.

7. Adjust the position of the tool laterally on the tripod plate so that the laser plummet is exactly centered on the ground.
8. Before the tool can be started, the electronic “circular bubble level” must be centered by turning the footscrews so that the tool is reasonably level.



The arrows show in which direction the tribrach footscrews must be turned in order to center the “bubbles”.

9. Check that the laser plummet is aligned exactly with the mark on the floor or ground and then move the tool on the tripod plate if necessary.
10. Start the tool.



The OK button becomes active when the level bubbles for longitudinal (L) and transverse (T) are within a total inclination of 50”.

5.8.3 Setting up over a pipe using the laser plummet

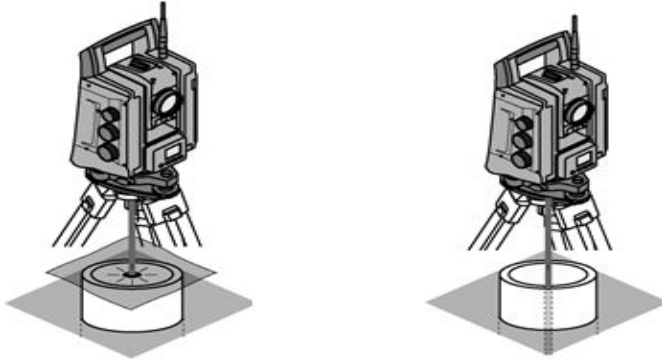

Pipes are often used to mark points on the ground.

In this case, the laser beam is projected into the pipe and the point cannot be seen.

Lay a piece of paper, foil or other semi-translucent material on the pipe in order to make the laser point visible.

6 System settings

6.1 Configuration

The **Config** configuration button, which can be used to make the basic system settings, is located on the lowest line of the main configuration menu.

Menu buttons are located in the following configuration menu.

6.2 Settings

Possible settings → page 28

Possible settings

Coordinate display with options	ENH, NEH, XYH, YXH, XYZ, YXZ
Decimal format	Dot (1000.0) Comma (1000,0)
Angle units	Degrees-minutes-seconds Gon
Angle resolution in display in accordance with angle unit selection	1", 5", 10" 5 cc, 10 cc, 20 cc
Distance units	Meters US feet, int feet, ft/in-1/8, ft/in-1/16
Zero setting for vertical circle	Zenith Horizon
Automatic power-off	On Off
Beep	On Off
Language	Selecting different languages for the displays

6.3 Calibrating the display

This is a Windows function which can be used to redefine the display dimensions from time to time. Follow the Windows instructions.

6.4 Time and date

The date and time are then taken from Windows. There are no setting options.

6.5 In-the-field calibration

The total station calibration function (in-the-field calibration) enables the operator to check the tool and to adjust the tool parameters electronically.

The tool is correctly adjusted when supplied.

The values to which the tool is set may change over time or due to temperature fluctuations, transport or aging. The tool therefore incorporates a feature that allows the settings to be checked and, if necessary, corrected by carrying out in-the-field re-calibration.

This is done by setting up the tool securely on a tripod of good quality and targeting an easily visible, clearly discernible object within ± 3 degrees of horizontal at a distance of approx. 70 - 120 m.

Interactive instructions for this procedure are shown in the display, so it is simply a matter of following the instructions.



Follow the instructions on the display

This application calibrates and adjusts the following axes of the tool:

- Target axis
- VA collimation
- Dual-axis compensator (both axes)
- Automatic prism target axis



The in-the-field calibration procedure requires great care and each step must be carried out very exactly. Imprecise sighting or vibration of the tool can result in incorrect calibration values, leading to subsequent measurement errors.



In the event of uncertainty, the tool should be returned to the **Hilti** Repair Service for checking.

6.6 Hilti Repair Service

The **Hilti** Repair Service checks the tool and, if deviations from the specified accuracy are found, recalibrates it and checks it again to ensure conformity with specifications. The Service Certificate provides written confirmation of conformity with specifications at the time of the check.

Recommendation

- Have the tool checked at suitable intervals, depending on how heavily it is used.
- Have the tool checked by the **Hilti** Repair Service at least once a year.
- Have the tool checked by the **Hilti** Repair Service if it has been subjected to exceptional stress or unusually harsh conditions.
- Have the tool checked by the **Hilti** Repair Service before using it for important work.

Having the tool checked by the **Hilti** Repair Service does not relieve the user of his/her obligation to check the tool before and during use.

6.7 Prism settings



The prism settings are necessary as different prisms require different corrections for calculating distances. These corrections are mainly the prism constants that can be entered manually for the operator's prism.

6.8 Search parameter settings

One of the most important functions of the motorized total station is prism tracking and prism search. To optimize the prism search, various parameters can be adjusted.

Search parameters → page 30

Search parameters

Search parameters	Setting options
Prism contact loss	Extrapolate, Stop
Extrapolation time	1, 2, 3, 5 seconds
Search sector (horizontal)	1-90° in 1° increments 1-100 gon in gon increments
Search sector (vertical)	1-90° in 1° increments 1-100 gon in gon increments

6.9 System information (I)

Display of system information

- Controller type
- Application software version
- Operating system version

The POS option displays the following total station information:

Total station information

- Total station type
- Total station serial number
- Total station firmware version

6.10 Settings for EDM and standard target

This setting defines which distance measurement method and which target are to be used as standard. Although the system always remembers the last settings, there are some system states which require the tool to revert to the standard settings.

EDM and standard target → page 30

EDM and standard target

Search parameters	Setting options
Standard EDM	Automatic target Manual Reflectorless (RL)
Standard target	360° standard prism POA 20 360° mini prism POA 21 Setting out prism POA 22 Wall prism POA 23 Reflector foil 360° sliding prism POA 53 User-defined prism

6.11 Function assignment for F1 and F2 buttons

In this setting, the F1 and F2 function buttons can be assigned to corresponding functions from a list.

The function button can be called up at any time and makes available the assigned function.

Function allocation for F1 and F2 buttons → page 30



It is not possible to call up a function within a function. In some cases, it may be that this function makes no sense at a certain time or for a certain state within an application. In this case, a corresponding warning message is given.

Function allocation for F1 and F2 buttons

Function list	Description
Select target type	The target type can be selected here at any time, e.g. from the 360° prism to the reflective foil, etc.

Function list	Description
Switch between prism and RL and the laser pointer	Switch EDM type between prism and reflectorless measurement with laser pointer – activated by pressing the button.
Check reference point	Quick check of a reference point during an application. Automatically targets a selected reference point and shows the coordinate differences. Returns to the starting application when confirmed.
Guide light	Changes the guide light settings at the touch of a button to the following sequences: <ul style="list-style-type: none"> • Off • Normal • Fast • Auto = switches to “normal” setting if the prism target is lost in the prism tracking mode.
Measurement (Meas)	Measurement of distance and angle at the touch of a button
Distance measurement and angle measurement separately (Dist and Rec)	Starts the distance measurement and angle measurement separately function (Dist and Rec)
Delete last saved measuring point	Deletes the last measuring point from the data memory

7 Function menu (FNC)

7.1 Selecting the function

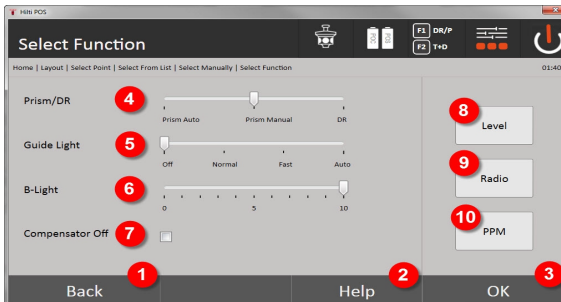

1. Return to previous dialog
2. Open manual
3. Confirm the dialog
4. Select measuring mode
5. Guide light: Normal, fast, automatic, switch off
6. Adjust backlight
7. Compensator on / off
8. Bubble level: Bring up the electronic level and laser plummet
9. Radio connection on / off, select radio channel
10. PPM: Settings for atmospheric corrections

7.2 Guide light



The guide light comprises an exit aperture on the telescope, half of which emits green and half red light.

Four different settings are possible:

- Off
- Flashing frequency – slow
- Flashing frequency – fast
- Flashing frequency – auto

With this setting, the light flashes only if there is a loss of connection to the prism, otherwise it is off. In the activated state, a person can see either the green or the red light, depending on which side of the sighting line the person is located. A person is in the sighting line if both colors can be seen at the same time.

Setting options → page 32

Setting options

Settings	Setting options
Setting changes each time a button is pressed	Off Normal = standard flashing frequency Fast = fast flashing frequency Auto = standard flashing frequency ON when target tracking has lost the prism. Standard flashing frequency off when the prism has been sighted.

7.3 Compensator

The tool is equipped with a dual-axis, electronic bubble level (= compensator).

This compensator measures the inclination of the tool. Following leveling of the tool, precise remaining inclinations are measured which are then used to calculate the corresponding angle corrections for steeper sightings. Error messages may be generated as a result of uneven ground or floor, e.g. formwork. To avoid this, the compensator can be switched off. However, this means that no angle corrections are made for steeper sightings.

Setting options → page 32



For horizontal sightings, the residual inclination of the tool has no effect on the angle measurement.

Setting options

Settings	Setting options
Setting changes each time a button is pressed	Off: No angle corrections due to tool tilt On: Angle corrections due to tool tilt

7.4 Laser pointer

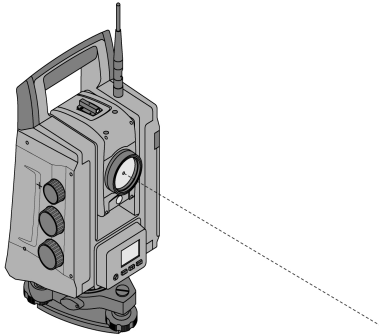

The tool is equipped with an EDM with various settings, depending on the objective. With the **Reflectorless measuring (RL)** EDM setting, the visible laser beam can be switched on permanently (laser pointer).

The laser pointer can be used indoors as a visible measuring and layout point.

7.5 Correction of atmospheric influences

This tool uses laser light to measure distances. As a fundamental principle, when light passes through the air, its speed is changed due to the density of the air. This influence varies according to the air density. Air density depends to a great extent on air pressure and air temperature and to a significantly lesser extent on air humidity. If distances are to be measured accurately, it is essential that atmospheric influences are taken into account. The tool calculates and corrects the corresponding distances automatically, but the temperature and pressure of the surrounding air must first be entered. These parameters can be entered in various units.

When the **ppm** button is pressed, atmospheric parameters can be entered to correct each distance measured by the corresponding ppm variable. Select the applicable units and enter the pressure and temperature.

Setting options → page 33



The distance corrections are output in ppm (parts per million). 10 ppm correspond to 10 mm / kilometer or 1 mm / 100 m.

Setting options

Settings	Setting options
Air pressure unit	hPa mmHg mbar inHg psi
Temperature unit	°C °F

7.6 EDM settings

Various measurement settings can be selected for the EDM (Electronic Distance Meter) using the EDM button.

The setting changes each time the button is pressed:

- Prism Auto: Automatic prism tracking and continual distance measurement
- Prism Manual: Distance measurement at the touch of a button
- RL and pointer: Reflectorless distance measurement with laser pointer switched on

7.7 Display illumination

Display illumination can be switched on / off using the display illumination button.

When switched on, the intensity of the illumination can be varied over five levels from 1/5 to 5/5 by continuing to press the display illumination button.

i The brighter the display, the more power is consumed.

7.8 Bubble level (compensator)

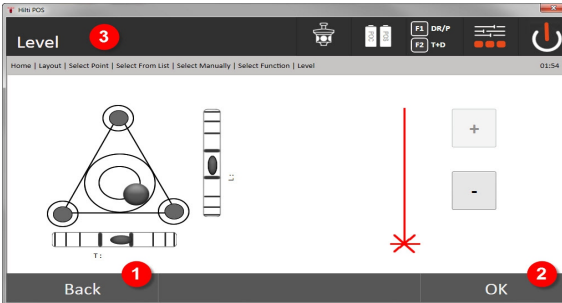



1. Return to previous dialog
2. Confirm current dialog
3. Title bar: Level tool

Level tool → page 34

i The **(OK)** confirm button becomes active when the level bubbles for longitudinal (L) and transverse (T) are within a total inclination of 50". The heavier the line for the **laser plummet light** symbol, the more intense the laser light.

i Before applications can be started, the electronic bubble level must be centered by turning the footscrews so that the tool is reasonably level. The arrows show in which direction the tribrach footscrews require to be turned in order to center the “bubbles”.

Level tool

	Increases laser plummet intensity (settings 1 -4)
	Reduces laser plummet intensity (settings 1 -4)

7.9 Help button

The **Help** button can be used to call up the help screen for the current dialog at any point in the system. The help screen refers to the current content of the dialog.

8 Functions for applications

8.1 Projects

A project has to be opened or created before the total station is used for an application. If at least one project already exists, the project selection is displayed. If there are no projects, then the screen for creating a new project is shown.

All data is assigned to the active project and saved accordingly.

8.1.1 Showing the active project

If one or more projects are already present in memory and one of these is to be used as the active project, the project has to be confirmed each time an application is restarted, when another project is selected or when a new project is created.

8.1.2 Selecting a project

From the list shown, select the project that is to be used as the current project.

8.1.3 Creating a new project

All data is always assigned to a project.

A new project should be created when data is assigned to something new and the data is to be used only for that purpose.

The date and time of creation are saved when a new project is created and the number of stations and points within the project is set to zero.



An error message is displayed when an incorrect entry is made and the user is requested to re-enter the data.

8.1.4 Project information

The current status of the project is shown with the project information, e.g. date and time of creation, number of stations and total number of the points saved.

8.2 Setting a station and orientation

Please pay particular attention to the information given in this section.

Setting a station is one of the most important operations when using a total station and must be carried out with great care.

The simplest and most reliable method of achieving this involves setting up the tool over a (known) point on the floor or ground and using a reliable target point.

The **Set the station “anywhere”** option offers greater flexibility but presents risks in that errors may not be identified and then transferred or multiplied as the work proceeds, etc.

Moreover, this method requires a little experience in selecting the tool position relative to the reference points used for position calculation.



Please bear in mind the following: If the station is set incorrectly, everything subsequently measured from this station will be incorrect. This includes the actual work such as measurements, layouts and installations.

8.2.1 Overview

Setting of the station and orientation is required in order to position the tool in the corresponding coordinate environment. Setting the station positions the tool within the coordinate system, and orientation aligns the horizontal circle of angles.

The process for setting the station offers various options:

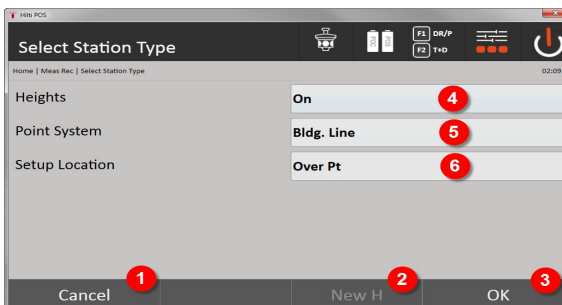

Select station type

1. Return to previous dialog
2. When heights are used, a new height can be set (even after setting the station has been completed)
3. Confirm the dialog
4. Switch use of heights on / off
5. Select the point system, coordinates or control lines
6. Select the station setting type: Over a point or “anywhere”

i If heights are switched off when setting the station, all relevant height values (height, HR, HI) are not displayed.

If, when setting the station, the **Station anywhere** option is selected, the coordinate system is defined by way of the reference points. All reference points have coordinates. If, when setting the station, the control line is selected, the coordinate system is defined by way of the control line points. The control line points can be measured directly, and no coordinates have to be known (in contrast to setting the station anywhere).

8.2.2 Setting the station over a point

On many construction sites, measured points with coordinates already exist, or the positions of parts of the structure, control lines or foundations etc. are already described with coordinates.

The tool is set up over a point marked on the floor or ground, the position of which is defined by coordinates and from which the points or elements to be measured are easily visible. Special care must be taken to ensure that the tripod stands steadily and securely.

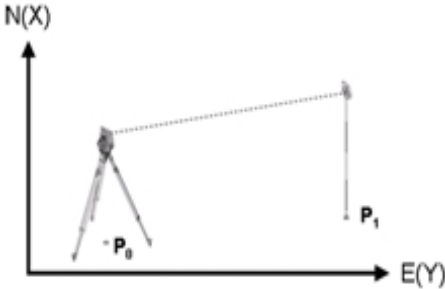

The tool is positioned at coordinate point P0 and targets another coordinate point P1 for orientation. The tool calculates the position within the coordinate system.

For better identification of the orientation point, the distance can be measured and compared with the distance calculated from the coordinates. This makes correct selection of the target point more reliable.

i If the coordinate point P0 also has a height, this will first be used as the station height. The height of the station can be redetermined and changed at any time before the station is set finally.

1. Selecting the station setting type

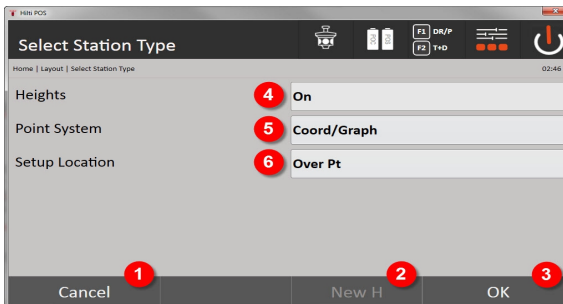

1. Return to previous dialog
2. When heights are used, a new height can be set (even after setting the station has been completed)
3. Confirm the dialog
4. Switch use of heights on / off
5. Select the point system: Coordinates
6. Select the station setting type: Station set over a point

2. Selecting a station point

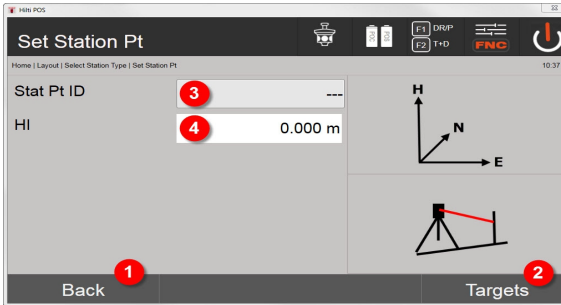

1. Return to previous dialog
2. Select the target points
3. Select the station point
4. Set the height of the tool

3. Selecting orientation points

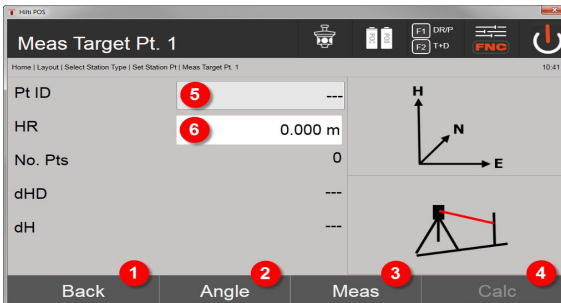

5. Return to previous dialog
6. Set the orientation angle (only the angle is to set, no measurement is taken)
7. Take the measurement to the orientation point
8. Start the calculation (possible only after at least one orientation point has been measured)
9. Select the station point
10. Set the reflector height

4. Selecting the orientation points or starting the calculation

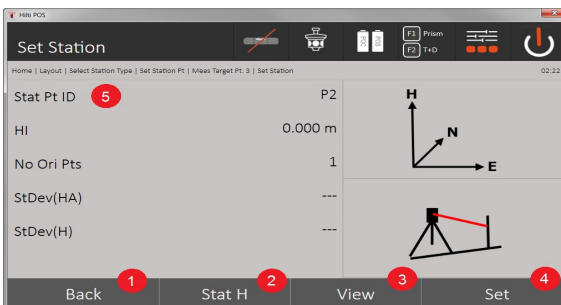

11. Return to previous dialog
12. Set the height of the station
13. Display results
14. Set station
15. Set the station name

Measuring BM height

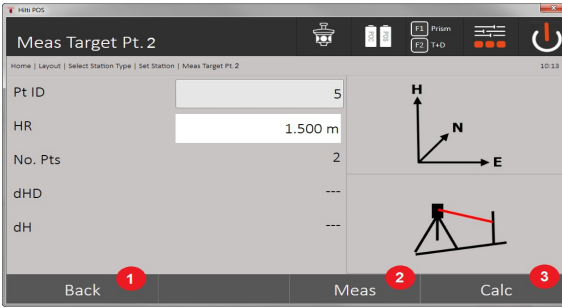

16. Return to previous dialog
17. Enter the height manually
18. Start measurement
19. Confirm the dialog
20. Select the height point
21. Reference height of the point
22. Set the height of the tool
23. Set the reflector height

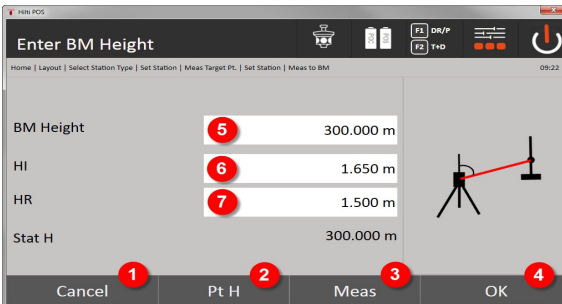

24. Return to previous dialog
25. Select the height above the point
26. Start measurement
27. Confirm the dialog
28. Enter the height manually
29. Set the height of the tool
30. Set the reflector height

After entering a height manually, **3** can be used to target and measure a height point. The station height is calculated on the basis of the measurements to the height point / height mark.

After entering the heights manually, **4** can be used to set the station height directly, without having to take a measurement.



If the **Heights** option is active, a height must be assigned to the station, i.e. a height value must exist. If a station height is not set or available, an error message appears with the prompt to set the station height.

8.2.3 Setting a station “anywhere”

Setting the station “anywhere” allows the position of the station to be defined by measuring the angles and distances to two reference points. The ability to set the station “anywhere” is used when it is not possible to set it over a point or when the line of sight to the points to be measured is obstructed. Extra care must be taken when setting the station “anywhere”. In order to set the station “anywhere”, additional measurements are taken. Additional measurements always present a risk of errors. Care must also be taken to ensure that the geometric relationships allow a usable position to be achieved.

The tool checks the basic geometric relationships in order to ensure that a usable position can be calculated and issues a warning in critical situations. Nevertheless, the user of the tool is obliged to exercise special caution in this respect as the software is not capable of recognizing all potentially critical situations.

Setting up the tool “anywhere”

An unobstructed and convenient location should be chosen for setting up the tool, where at least two coordinate points are clearly visible and where a good line of sight to the points to be measured can be ensured as far as possible. It is recommended that a mark is always first made on the floor or ground and the tool then set up over this mark. This allows the position to be checked subsequently in the event of uncertainties.

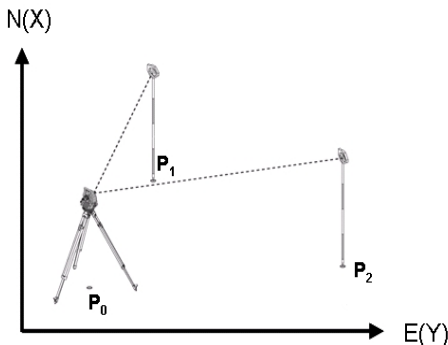

The tool is positioned at any free P0 point and measures, one after the other, the angles and distances to two or more reference points with coordinates P1, P2 and PX. The position of the tool is then calculated from the measurements taken to the two reference points.

1. Start setting the station



1. Return to previous dialog
2. Adopt station from last project
3. Start new setting the station
4. Select a project
5. Confirm the dialog
6. Current project

2. Selecting the station setting type

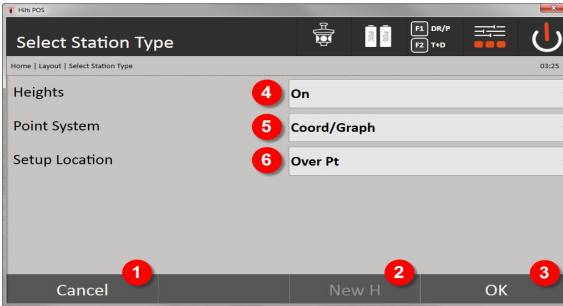

7. Return to previous dialog
8. When heights are used, a new height can be set (even after setting the station has been completed)
9. Confirm the dialog
10. Switch use of heights on / off
11. Select the point system: Coordinates
12. Select station setting type: Setting a station “anywhere”

3. Give the station a name

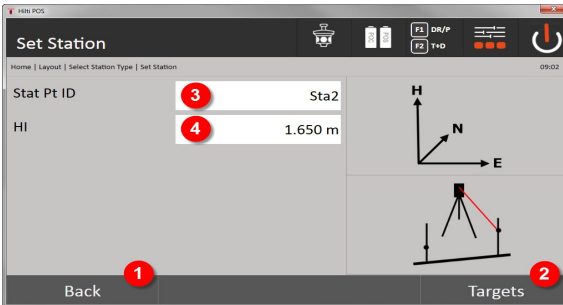

13. Return to previous dialog
14. Start dialog for measuring the reference points
15. Give the station a name
16. Set the height of the tool

4. Select the reference points

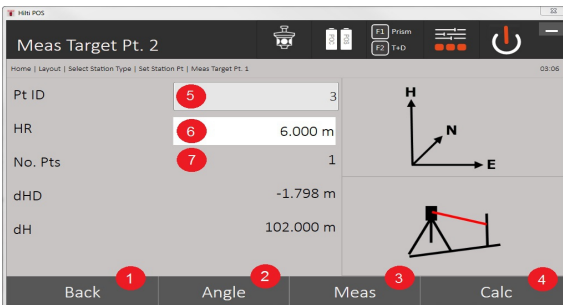

17. Return to previous view
18. Define the angle of the target point
19. Measure the target point
20. Calculate the station
21. Enter the point ID
22. Enter the reflector height

23. Number of measured reference points

Select a reference point and take the measurement.

Repeat steps 4 and 2 until the desired number of reference points for determining the station have been measured.



At least two reference points have to be measured in order to be able to calculate a station.

5. Setting a station

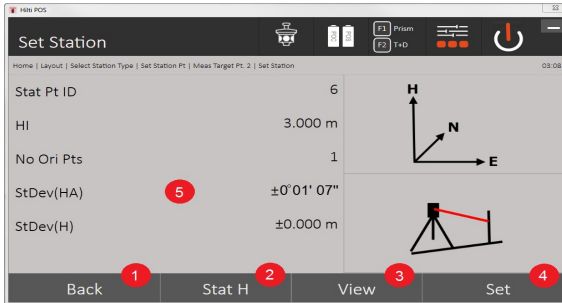

24. Return to previous dialog

25. Set the height of the station

26. Display results

27. Set station

28. Results of the station calculation are displayed

6. Setting the height of the station

If the station point and / or the connected point or points have heights, these heights are averaged and adopted. If the points have no height, the height can now be determined from a reference point or from a height mark.

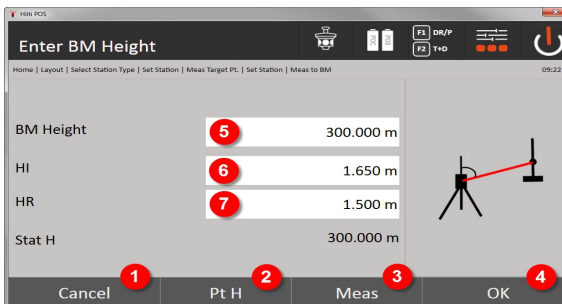

29. Return to previous dialog

30. Select the height above the point

31. Start measurement

32. Confirm the dialog

33. Select the height point / height mark

34. Set the height of the tool

35. Set the reflector height

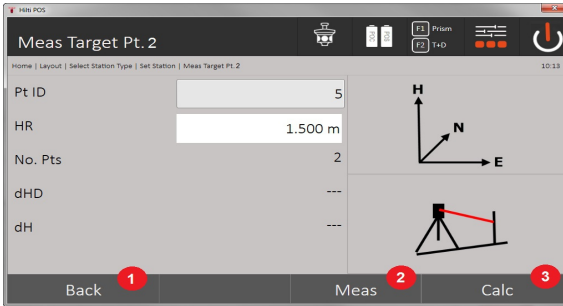

36. Return to previous dialog
37. Enter the height manually
38. Start measurement
39. Confirm the dialog
40. Select the reference point
41. Height of the reference point
42. Enter the height of the tool
43. Enter the reflector height

After entering a height manually, **3** can be used to target and measure a height point. The station height is calculated on the basis of the measurements to the height point / height mark.

After entering the heights manually, **4** can be used to set the station height directly, without having to take a measurement.



If the **Heights** option is active, a height must be assigned to the station, i.e. a height value must exist. If a station height is not set or available, an error message appears with the prompt to set the station height.

8.2.4 Station with control line

Two options are available:

1. Control line with two points
2. Control line with three points

8.2.4.1 Control line with 2 points

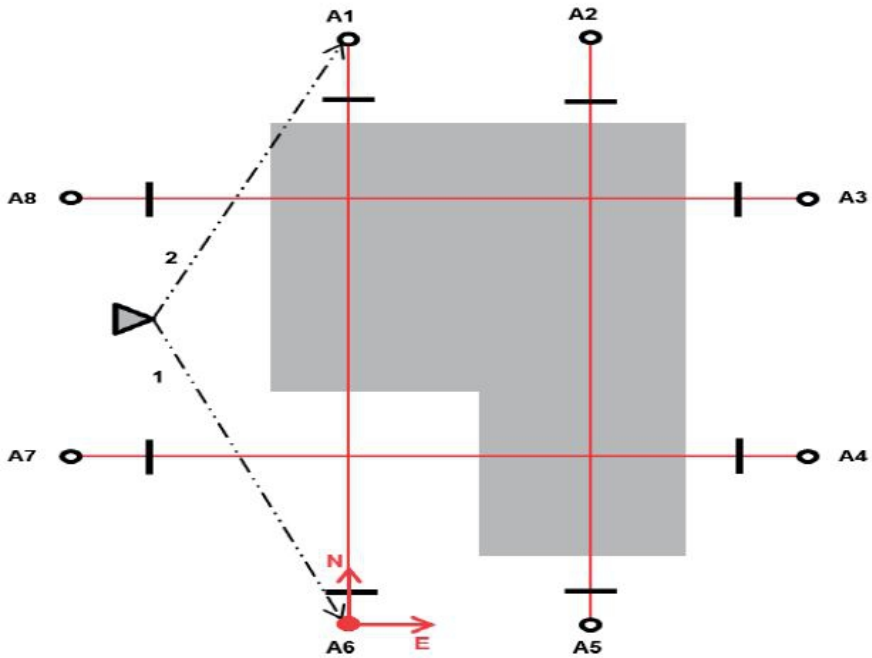

The tool is positioned at any point and measures, one after the other, the angles and distances to two control line points. The position of the tool is subsequently calculated from the measurements to the two control line points and the zero point of the coordinate system is set as the first measured control line point. Orientation (longitudinal value) is toward the second measured control line point. The coordinates of the control line points do not have to be known.

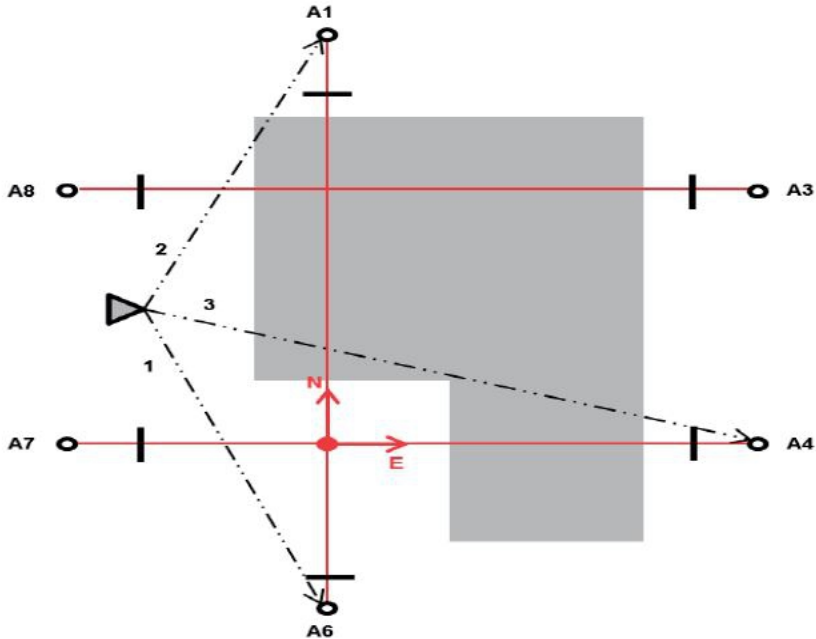

The tool is positioned at any point and measures, one after the other, the angles and distances to two control line points. The position of the tool is subsequently calculated from the measurements to the three control line points and the zero point of the coordinate system is the projection of the third measured control line point, perpendicular to the axis of the two points measured first. Orientation (longitudinal value) is toward the second measured control line point. The coordinates of the control line points do not have to be known.

1. Selecting the station setting type

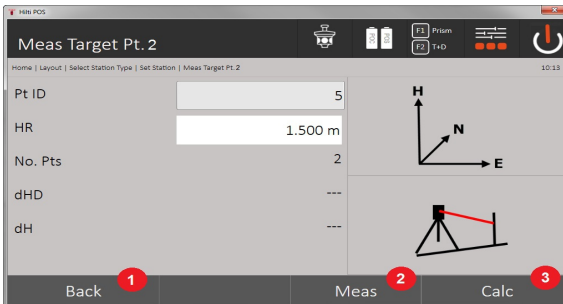

1. Return to previous dialog
2. When heights are used, a new height can be set (even after setting the station has been completed)
3. Confirm the dialog
4. Switch use of heights on / off
5. Select the point system
6. Select the station setting type

2. Selecting control line point 1

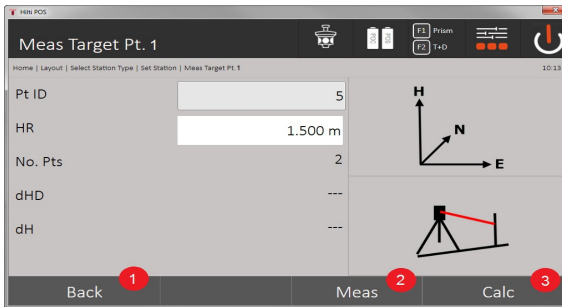

7. Return to previous dialog
8. Start the measurement to the reference point
9. Start the calculation (possible only after at least two reference points have been measured)

3. Selecting control line point 2

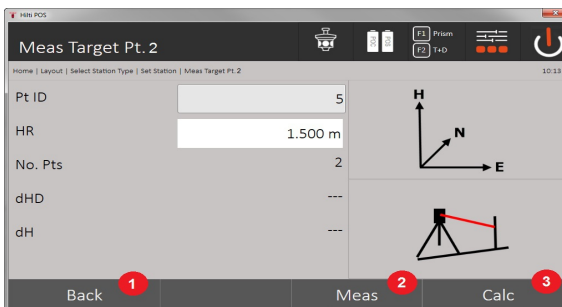

10. Return to previous dialog
11. Start the measurement to the reference point
12. Start the calculation (possible only after at least two reference points have been measured)

 When measuring the 3 control line points, also measure the third point.

4. Setting a station

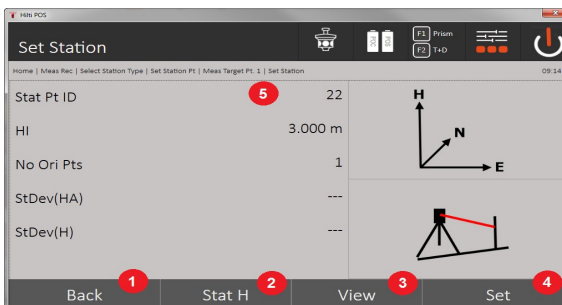

13. Return to previous dialog
14. Set the height of the station
15. Display results
16. Set station
17. Display the name of the station

5. Setting the height of the station

If the points have a height, these heights are averaged and adopted. If the points have no height, the height can now be set from a reference point or from a height mark.

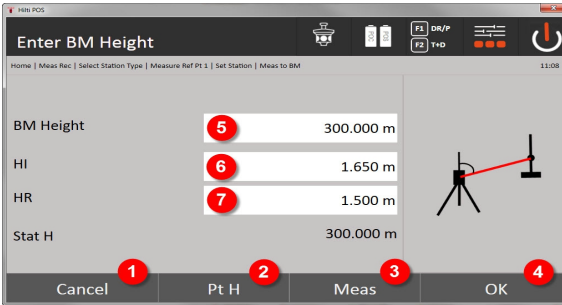

18. Return to previous dialog
19. Select the height above the point
20. Start measurement
21. Confirm the dialog
22. Enter the height manually
23. Set the height of the tool
24. Set the reflector height

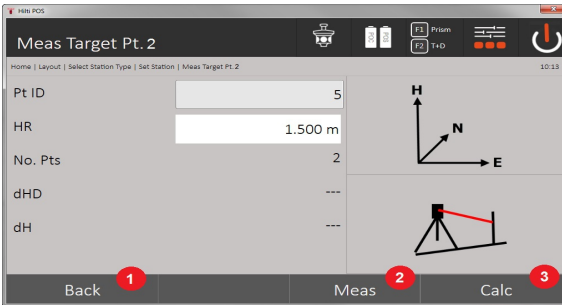

25. Return to previous dialog
26. Enter the height manually
27. Start measurement
28. Confirm the dialog
29. Select the reference point
30. Height of the reference point
31. Enter the height of the tool
32. Enter the reflector height

After entering a height manually, **3** can be used to target and measure a height point. The station height is calculated on the basis of the measurements to the height point / height mark.

After entering the heights manually, **4** can be used to set the station height directly, without having to take a measurement.

If the **Heights** option is active, a height must be assigned to the station, i.e. a height value must exist. If a station height is not set or available, an error message appears with the prompt to set the station height.

8.2.5 Set station

The station is always saved in the internal memory. If the station name already exists in the memory, the station must be renamed. i.e. a new name assigned to it.

8.2.6 Setting up the tool with height

If heights are also to be used in addition to setting the station and orientation, i.e. target heights are to be determined or laid out, the height of the center of the telescope must also be defined.

Methods for setting the height

- If the height of the point on the floor or ground is known when setting up over a point on the floor or ground, the height of the tool is measured. The height of the center of the telescope is the sum of these two values.
- If the height of the point on the floor or ground is not known, e.g. when setting up “anywhere”, the height at the center of the telescope can be determined and transferred back to the tool by measuring the angle and distance to a point or mark for which the height is known.

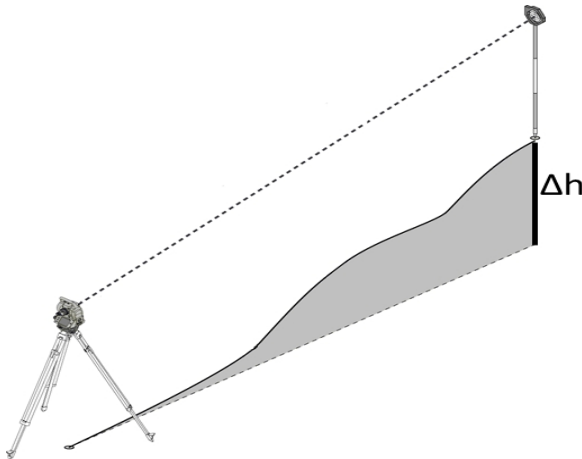

Dialog for determining height

BM Pt ID	5	---
BM Height	6	---
HI	7	1.500 m
HR	8	1.650 m
Stat H		---

1. Return to previous dialog
2. Enter the height manually
3. Start measurement
4. Confirm the dialog
5. Select the height point
6. Height
7. Set the height of the tool
8. Set the reflector height

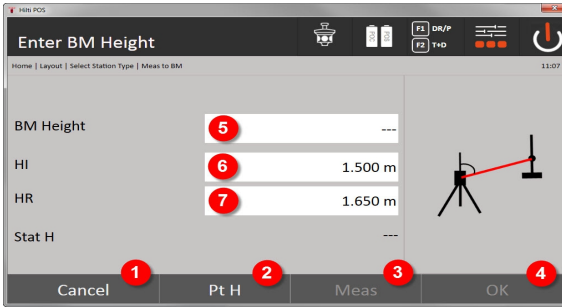

9. Return to previous dialog
10. Select the height above the point
11. Start measurement
12. Confirm the dialog
13. Select the height point / height mark
14. Set the height of the tool
15. Set the reflector height

After entering a height manually, **3** can be used to target and measure a height point. The station height is calculated on the basis of the measurements to the height point / height mark.

After entering the heights manually, **4** can be used to set the station height directly, without having to take a measurement.

i If the **Heights** option is active, a height must be assigned to the station, i.e. a height value must exist. If a station height is not set or available, an error message appears with the prompt to set the station height.

9 Applications

9.1 Horizontal layout

The horizontal layout application is used to transfer data from the plan to the actual object or construction site. The data from the plans are positions that are described using coordinates. The data from the plans and layout positions can be entered using coordinates, transferred from a PC or imported from a USB data storage device. Plan data in the form of CAD drawings can be transferred to the total station from the PC and the applicable graphical point or graphical element for the layout then selected on the total station. This makes working with long numbers or lots of numbers unnecessary.

9.1.1 Principle of the layout procedure

In principle, the **Hilti** total station system POS 150 / 180 comes in two different layout procedures – prism or laser mode – depending on the EDM mode.

Layout procedure

- Layouts with prism
 - With the prism, points are always set out when they are either outside or on the ground, i.e. when work can be carried out with a prism or a rod.
- Layouts with a visible laser pointer including distance measurement
 - The laser pointer is used particularly for setting out indoors, where the laser point can be seen most clearly, for example in large industrial buildings. The total station is suitable for use at distances of over 5 m and where there are suitable light conditions, for example, not in bright sunlight.

9.1.2 Setting out (layout) with prism

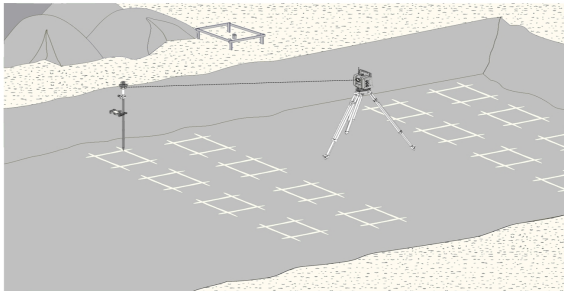
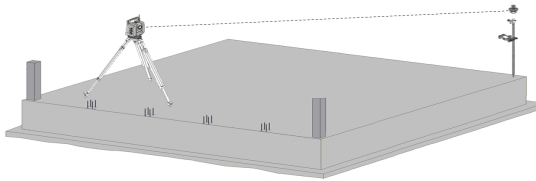

In this procedure, the EDM is set to **Autolock** and prism search is activated on the controller using the search button in order to set up the optical connection between the prism and the total station. Before you can start setting out, the total station should be locked onto the prism, i.e. the total station tracks the prism. Layout in the prism corresponds to navigation to the layout position.

 To avoid having to align the prism constantly with the tool, it makes sense to work with a 360° prism.

9.1.3 Procedure for “Layout with prism” application

To start the **Horizontal layout** application, press the Horz. Layout button in the main menu.

1. “Layout” start dialog

Procedure for application

1. Project selection
2. Station definition and station setup

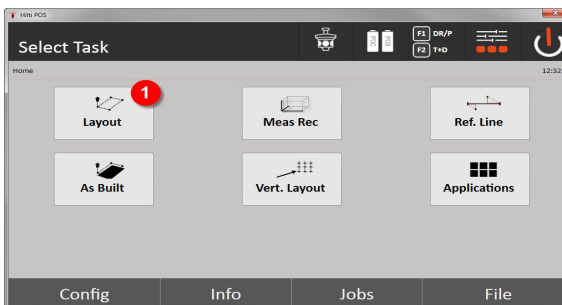

- Selecting the horizontal layout application.



3. Return to previous dialog
4. Adopt the last setting the station
5. Create a new station
6. Select a project
7. Confirm the dialog
8. Current project

“Layout point” entry dialog

Point coordinates for the layout points can be determined in three different ways:

Options for determining the point coordinates of layout points

- Enter manually
- Select from a list of saved points
- Select from a CAD drawing with saved points

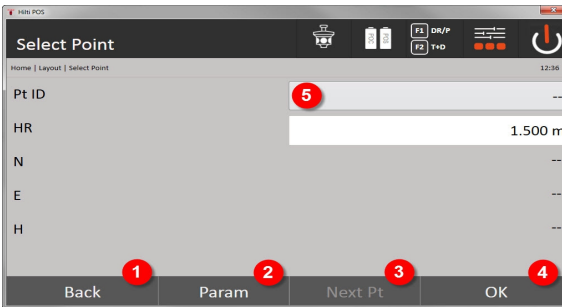

9. Return to previous view
10. Enter the layout settings. Sorting criteria for automatic point suggestion, automatic point tracking (on / off), layout tolerances, measuring delay, in order to align the prism rod sufficiently before the distance measurement
11. Select the next point if automatic point suggestion is selected in the settings
12. Confirm the dialog
13. Entry and selection field for layout point

3. Layout dialog (graphic display)

- Dialog with rough layout information for finding the new layout position
- Dialog with layout depiction for precise setting-out with graphic auto-zoom and numerical layout values. This dialog is called up automatically as soon as the prism position is within a radius of less than three meters.

In both dialogs, the layout corrections are displayed numerically in the top right-hand corner. The arrows show the direction in which the prism must be moved to reach the layout point. The arrow for the left / right direction always refers to the line between the current prism position and the total station.

Parameter dialog

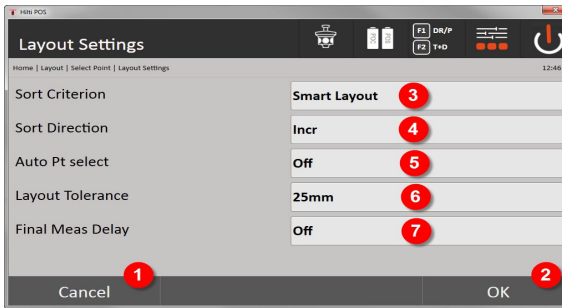

14. Return to previous dialog
15. Confirm the dialog
16. Select the sorting criterion, activate **Smart Layout**
17. Select the sorting sequence
18. Select whether the next point is to be automatically selected. Not necessary for **Smart Layout**.
19. Enter the layout tolerance
20. Set the measuring delay

Layout dialog

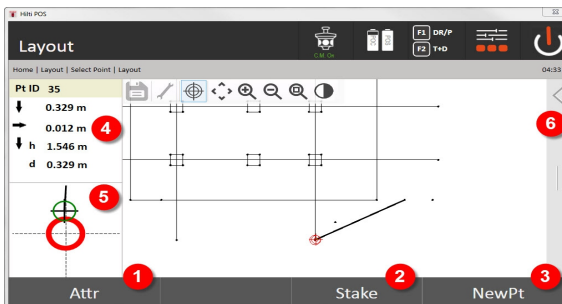

21. Display attributes
22. Lay out a point
23. Select a new point (not necessary for **Smart Layout**)
24. Directions to the point
25. Detailed graphic display of the point layout
26. Toolbar

4. Layout (optional)

The memory dialog can be used to store the current layout position for documentation purposes. A distance is automatically measured and the deviations from the given coordinates are displayed and saved when the display is confirmed. The stored data can be read, saved and printed using the **Hilti PROFIS Layout PC** software.

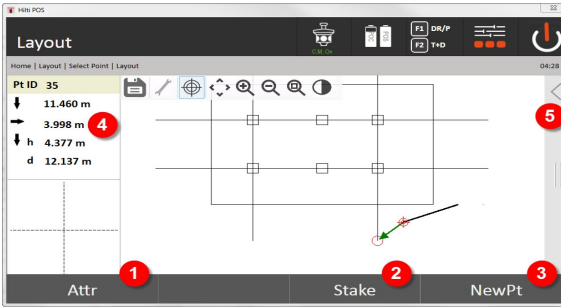

27. Display attributes
28. Lay out a point
29. Select a new point (not necessary for Smart Layout)
30. Display the directions to the point
31. Toolbar

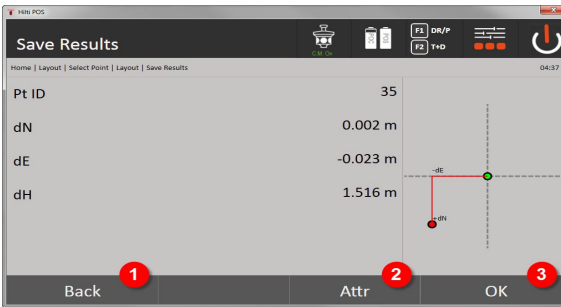

32. Return to previous dialog
33. Display of attributes for the layout point
34. Confirm the dialog

If the option to exclude heights is activated when setting up the station, height values and all associated information are not displayed.

Saving layout data → page 52

Saving layout data

Product number	Name of layout point
Northings (specified)	The northings entered refer to the coordinate reference system
Eastings (specified)	The eastings entered refer to the coordinate reference system
Height (specified)	Height entered
Northings (measured)	Measured northings refer to the coordinate reference system
Eastings (measured)	Measured eastings refer to the coordinate reference system
Height (measured)	Measured height
dN	dN = northings (measured) – northings (entered)
dE	dE = eastings (measured) – eastings (specified)
dH	dH = height (measured) – height (specified)
Attribute 1 – Attribute 5	Attributes assigned to the point

9.1.4 Layout with visible laser (laser pointer)

In this procedure, the EDM is set to **Laser on**. This ensures that for practical setting out with the red dot, the layout point is directly selected and the layout position virtually marked with the red dot.

As the red laser is more easily seen in lower ambient light, this application is primarily used indoors.

To enable the layout point to be directly selected in three dimensions, the station must be set up with the height values specified.

It is, however, also possible to set out using floors or ceilings without specification of heights. To do this, the laser must first be steered onto the area. In this case, the software attempts to find the corresponding point position or the corresponding plumbline on the area in question.



The “Layout” application with the red laser is suitable for layouts on floors and ceilings. The application is not suitable for layouts on the wall.

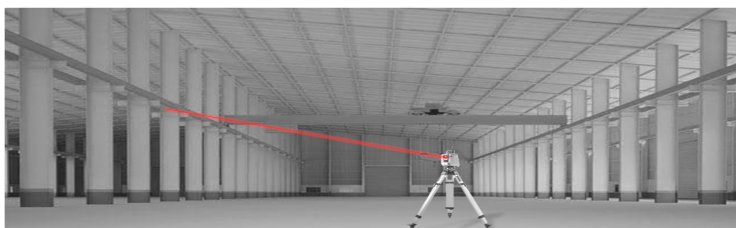

9.1.5 Procedure for “Layout with visible laser” application

1. “Layout” start dialog

To start the “Horizontal layout” application, press the **Horz. Layout** button in the main menu.

- Project selection
- Station definition and station setup

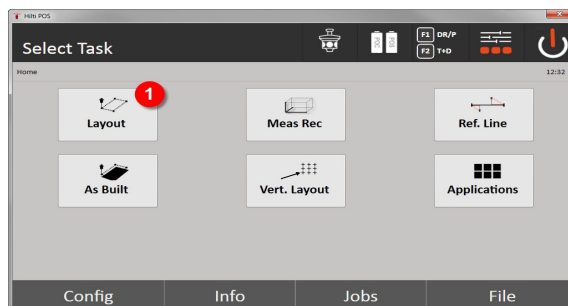

1. Select the horizontal layout application

2. Entry dialog

Options for determining the point coordinates of layout points

- Enter manually
- Select from a list of saved points
- Select from a CAD drawing with saved points

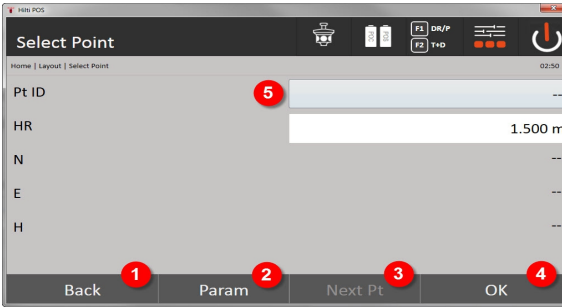

1. Return to previous view
2. Enter the layout settings: Sorting criteria for automatic point suggestion, automatic point tracking (on / off), layout tolerances, measuring delay, in order to align the prism rod sufficiently before the distance measurement
3. Select the next point if automatic point suggestion is selected in the settings
4. Confirm the dialog
5. Entry and selection field for layout point

 Switch the EDM to laser mode here at the latest. This can be done either in the **FindMe** dialog or in the **FNC** dialog.

Once entry of the layout point has been confirmed, the laser point is directly aligned to the target position, if the station has been used with height settings. Otherwise the currently targeted area is used.

The target position is only valid if the target point is directly on the target surface area. If this is not the case, the current position is compared with the target position. If the position is outside the set layout tolerance, this is displayed in an additional dialog. The operator can decide whether the plumb point should be steered onto the current surface. If the plumb position is to be selected, the laser point is projected in iteration steps onto the plumbline of the specified target point on the current surface.

The following sketch shows how the plumb position is reached from the entered target position (black dot) in 3 iteration steps.

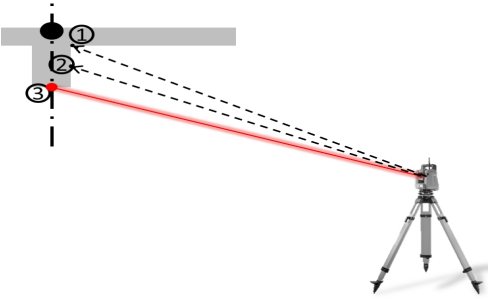

 Pay attention to the layout tolerance entry.

As soon as the difference in positions is within the layout tolerance, the iteration process is completed.

3. Layout dialog (graphic display)

The graphic display directly shows the precise layout dialog as the red dot “travels” directly to the layout position. In the dialog, the layout corrections are displayed numerically in the top left-hand corner. The values are “quasi” zero (within the set layout tolerance), as the red dot points directly to the position of the layout point – all that remains is the difference in height.

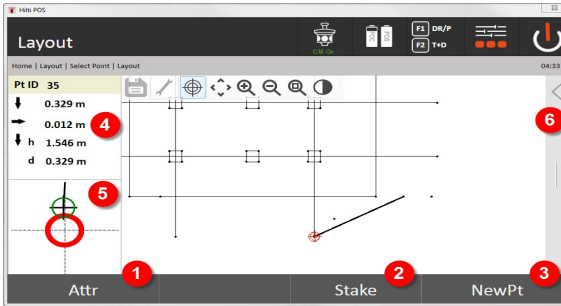

6. Display attributes
7. Lay out a point
8. Select a new point (not necessary for **Smart Layout**)
9. Directions to the point
10. Detailed graphic display of the point layout
11. Toolbar

i If the option to exclude heights is activated when setting up the station, height values and all associated information are not displayed. The other screens shown are the same as described in the previous section.

4. Memory dialog (optional)

The memory dialog can be used to store the current layout position for documentation purposes. A distance is automatically measured and the deviations from the given coordinates are displayed and saved when the display is confirmed. The stored data can be read, saved and printed using the **Hilti PROFIS Layout PC** software.

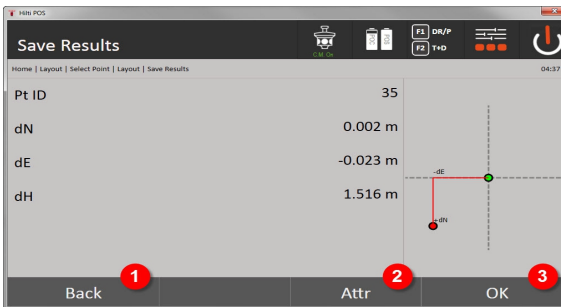

12. Return to previous dialog
13. Display of attributes for the layout point
14. Confirm the dialog

i If the option to exclude heights is activated when setting up the station, height values and all associated information are not displayed. The other screens shown are the same as described in the previous section.

Saving layout data → page 55

i Attributes are descriptions of the point and can be taken directly from AutoCAD or Revit together with the point coordinates using **Hilti Point Creator**, or entered manually.
The item number, description, layer, type of graphical element and color of **Hilti** products such as anchors, rails, etc. can be taken from AutoCAD or Revit. The CAD data can contain 2D or 3D data.

Saving layout data

Product number	Name of layout point
----------------	----------------------

Northings (specified)	The northings entered refer to the coordinate reference system
Eastings (specified)	The eastings entered refer to the coordinate reference system
Height (specified)	Height entered
Northings (measured)	Measured northings refer to the coordinate reference system
Eastings (measured)	Measured eastings refer to the coordinate reference system
Height (measured)	Measured height
dN	$dN = \text{northings (measured)} - \text{northings (entered)}$
dE	$dE = \text{eastings (measured)} - \text{eastings (specified)}$
dH	$dH = \text{height (measured)} - \text{height (specified)}$
Attribute 1 - Attribute 5	Attributes assigned to the point

9.2 Measuring and recording

9.2.1 The principle of measure and record

“Measure and record” can be used to measure points with an unknown position.

Distance measurements can be measured using the prism or laser. Prism measurements are suitable for use outdoors or in areas where a person can move with a prism. Measurements with the laser are suitable for measuring in areas that are difficult to access with the prism or indoors, where the laser point can be seen more easily.

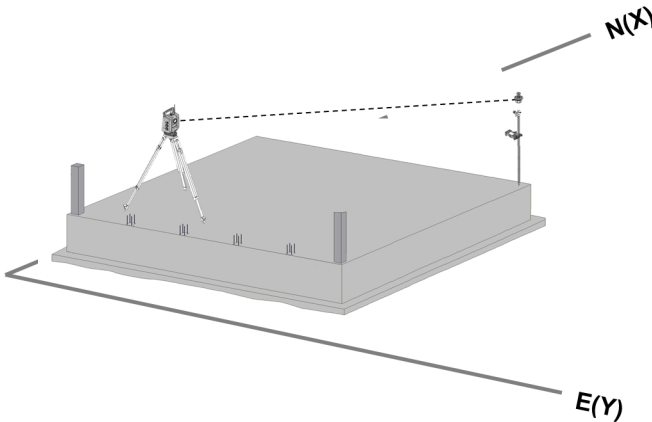

Point measurements with the prism can be carried out by tracking the prism with the EDM in “auto mode” and taking a measurement and saving data at each position. Alternatively, a prism can be manually sighted and the EDM operated in manual mode.

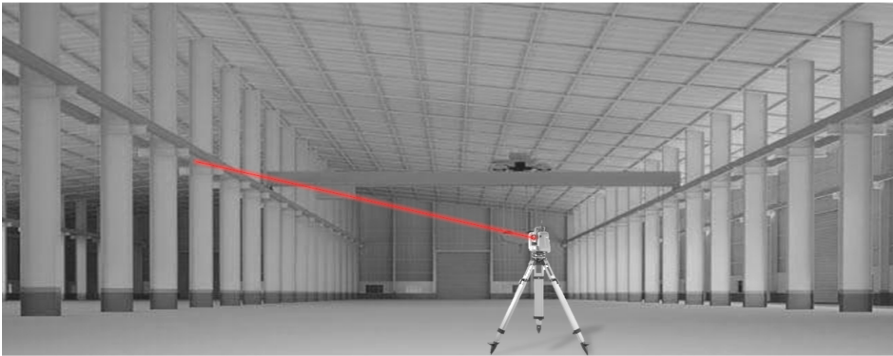

Point measurements with the visible laser can be carried out manually using the motorized drives or the remote control joystick.

When carrying out point measurements, it is essential to ensure that the laser point lines up with the cross hairs. If this is not the case, the tool must be recalibrated by the **Hilti Repair Service**.

The “Measure and record” application can be started by pressing the corresponding button in the application menu.

9.2.2 Procedure for “Measure and record” application

To start the “Measure and record” application, press the **Meas & Rec** button in the main menu.

1. “Measure and record” start dialog

- Project selection
- Station definition and station setup

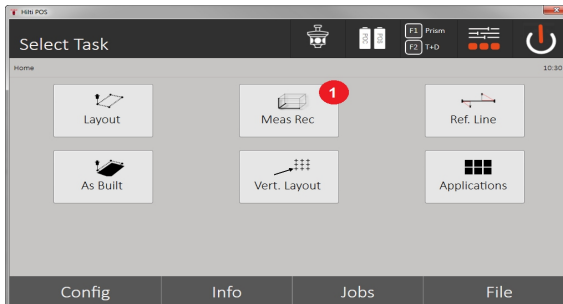

1. Selecting the “Measure and record” application

2. “Measuring point” measuring dialog

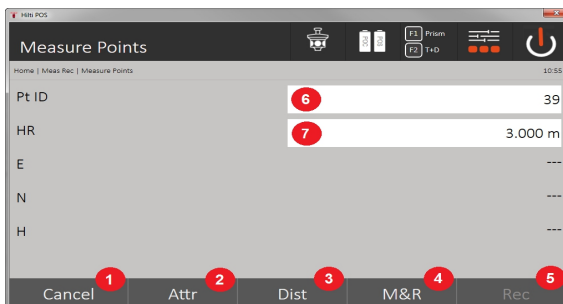

2. Cancel and return to previous screen

3. Enter and display the attributes for the corresponding measuring point. it is possible to enter up to five different attributes per measuring point.
4. Measure individual distance
5. Measure distances and angles at the touch of a button and save data at the same time
6. Following a valid distance measurement, angles are measured and the distance is then saved together with the angle
7. Enter the alphanumerical point designation
8. Enter the reflector height (if the station has been set up with heights)

Saving data for “Measure and record”



The points measured can be assigned various point designations and saved in the memory.

Each time a point is saved, the number assigned to the name of the point is raised by 1.

The point data saved in memory can be transferred to the PC for further use in a CAD or similar system or printed out for documentation and archival purposes. If the option to exclude heights is activated when setting up the station, height values and all associated information, such as reflector height, are not displayed.

Saving data for “Measure and record” → page 58

Saving data for “Measure and record”

Point number	Name and designation of the measuring point
Northings (specified)	Measured northings
Eastings (specified)	Measured eastings
Height (specified)	Measured height
Eastings (measured)	Applicable atmospheric correction (ppm)
Attribute 1 - Attribute 5	Attributes assigned to the point

9.3 Reference line

The reference line application is an application that deals with the handling of lines and curves. The “Reference line” application can be used to calculate and set out control lines using coordinates, to record control lines marked on the construction site and to move lines in a defined way. In addition, points with longitudinal and lateral dimensions with reference to the defined control line can be set out directly.

This is particularly easy when the control line is previously defined as a graphical line or curve using coordinates. The lines and curves can then be selected by the press of a finger without having to re-enter the lines or curves again when changes are made.

9.3.1 Principle of the reference line

Control line definition

Methods for defining the control line for lines and curves

- Line (2 points)
- Curve (2 points + radius)
- Curve (3 points)

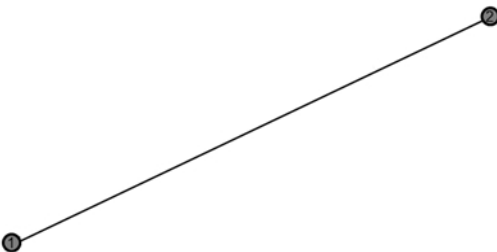

If the line or curve items are defined with points at different heights, the height is interpolated accordingly, depending on the longitudinal value.

Moving the control line

According to the control line definition, the control line can still be moved in three directions and can be rotated once.

Moving and rotating the control line

- Moving in a longitudinal direction
- Moving in the lateral direction
- Changing the height
- Rotating around the starting point

Control line measuring options

The control line measurements can be divided into two different applications:

- **Layout (longitudinal and lateral dimensions)**
Set out the points using entered line dimensions (longitudinal and lateral) in relation to the control line.
- **Survey (distance of point to control line)**
Measure points and display dimension (longitudinal and lateral) in relation to the control line.

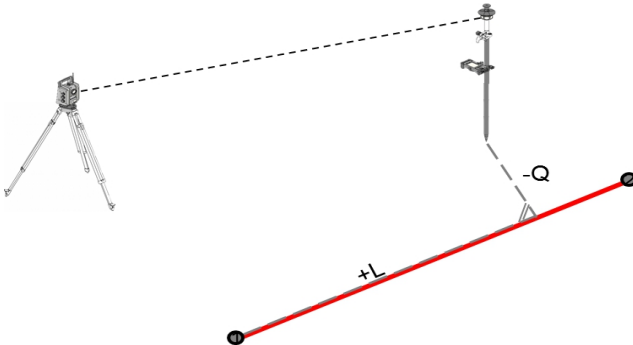

Depending on the selected function, the longitudinal and lateral values can be entered or measured.

9.3.2 Reference line with prism

In this procedure, the EDM is set to **Autolock** and prism search is activated on the controller using the search button in order to set up the optical connection between the prism and the total station.

Before you can start setting out, the total station should be locked onto the prism, i.e. the total station tracks the prism. Layout with the prism corresponds to navigation to the layout position.

Layout with entered longitudinal and lateral values is the same as for the **Horizontal layout** application.

9.3.2.1 Procedure for “Reference line with prism” application

To start the **Reference line** application, press the **Reference line** button in the main menu.

1. Reference line start dialog

- Project selection
- Station definition and station setup

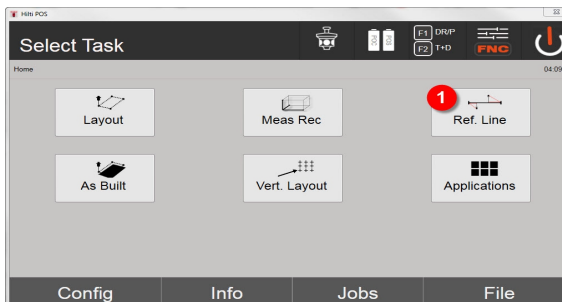

1. Selecting the “Reference line” application

2. Control line definition entry dialog

Control lines can be defined in three different ways for curves and lines:

- Graphically from a digital plan by tapping
- Using coordinates – entering or selecting coordinates from a coordinate list
- By measuring to two different axis points on the construction site



2. Return to previous dialog
3. Adopt the last setting the station
4. Create a new station
5. Select a project
6. Confirm the dialog
7. Current project

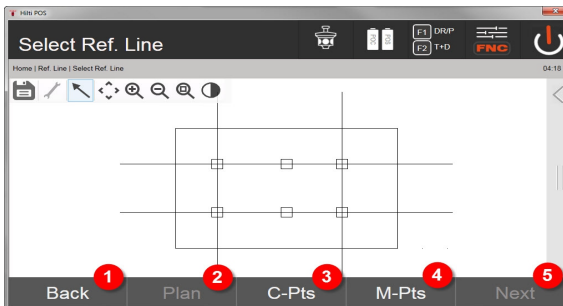

8. Return to previous dialog
9. Define and select control line from drawing
10. Define control line from coordinate list
11. Define control line from point measurement
12. If the control line has been defined, continue to shift dialog

3. Shifts entry dialog

- Enter the longitudinal, lateral and height shifts including angle of rotation

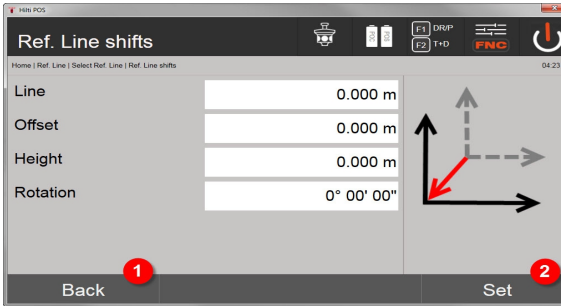

13. Return to control line definition

14. Confirm the shift entries. Continue with entry dialog for longitudinal, lateral and height values.

Option: Layout of longitudinal and lateral dimensions

“Longitudinal / lateral” entry dialog

- Enter the longitudinal, lateral and height shifts including angle of rotation

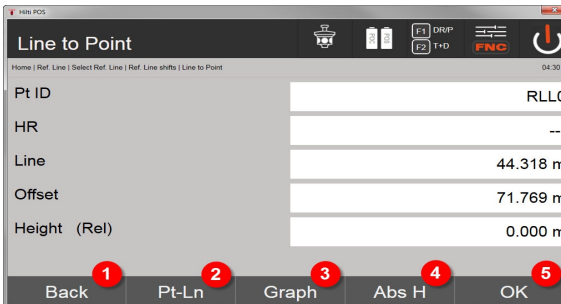

15. Return to shift dialog

16. Dialog for entering the layout parameters

17. Graphic display of the reference line

18. Changing between the absolute and relative height

19. Confirmation of the values entered

The dialog sequence beyond this point is the same as for the **Horizontal layout** application; the layout values are displayed and the layout differences and control line values are saved.

Option: Survey (distance of point to control line)

Measuring dialog with “Longitudinal / lateral” display

- Point measurement with display of calculated longitudinal and lateral values

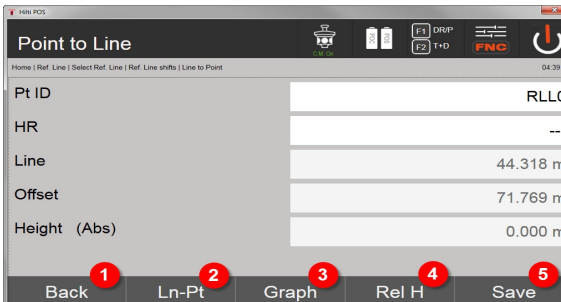

20. Return to shift dialog

21. Change to layout option for longitudinal and lateral values
22. Graphic display of the reference line
23. Change between the absolute and relative height
24. Save point

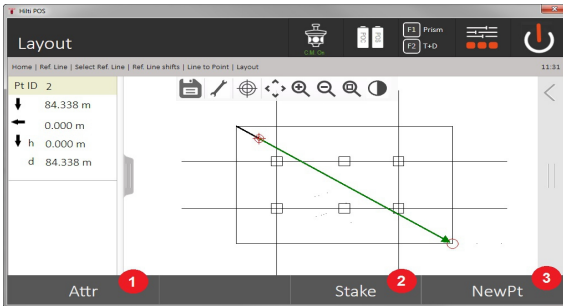

25. Return to previous dialog
26. Save point

9.3.3 Reference line with visible laser

In this procedure, the EDM is set to **Laser on**. This ensures that for practical setting out with the red dot, the layout point is directly selected and the layout position virtually marked with the red dot. As the red laser is more easily seen in lower ambient light, this application is primarily used indoors.

To enable the layout point to be directly selected in three dimensions, the station must be set up with the height values specified.

It is, however, also possible to set out using floors or ceilings without specification of heights. The laser must first be steered onto the area. In this case, the software attempts to find the point position or the corresponding plumbline on the area in question.



The "Layout" application with the red laser is suitable for layouts on floors and ceilings. The application is not suitable for layouts on the wall.



The procedure from this point is the same as for the prism. The layout and measuring process can be compared with the description for horizontal layouts.

9.3.4 Saving layout data

Product number	Name of layout point
Northings (specified)	The northings entered refer to the coordinate reference system
Eastings (specified)	The eastings entered refer to the coordinate reference system
Height (specified)	Height entered
Northings (measured)	Measured northings refer to the coordinate reference system
Eastings (measured)	Measured eastings refer to the coordinate reference system
Height (measured)	Measured height
dN	$dN = \text{northings (measured)} - \text{northings (entered)}$
dE	$dE = \text{eastings (measured)} - \text{eastings (specified)}$
dH	$dH = \text{height (measured)} - \text{height (specified)}$
Attribute 1 - Attribute 5	Attributes assigned to the point

9.4 Check

9.4.1 The checking principle

In principle, the check can be regarded as a reversal of the horizontal layout application.

With the check, existing positions are compared with their positions on the plan and the deviations shown and recorded accordingly.

Depending on how the station has been set up, the plan data and/or the positions to be compared, can take the form of dimensions, coordinates or points in graphics.

If plan data in the form of CAD drawings is transferred from a PC to the total station and the applicable graphical points or elements then selected from the display of the tool, there is no longer any need to work with long numbers or lots of numbers.

Typical applications are checking walls, columns, formwork, large openings and much more. These jobs are done by comparing positions on the plan with actual points on the object and displaying or recording the differences.

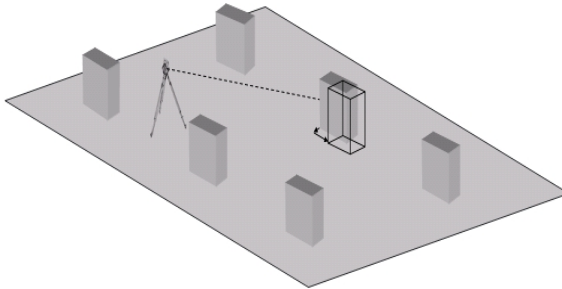

To start the “Check” application, select the corresponding button in the application menu. After starting the application, the projects or list of projects is shown for selection as well as the corresponding station selection or station setup. The “Check” application begins after station setup is completed.



Deviations from the given and the measured position can be saved and output as a report in **Hilti PROFIS** Layout.

9.4.2 Checking with the prism

To measure points as built, the position is first defined with an entry.

Entering the check point

Options for entering the point coordinates

- Enter the point coordinates manually
- Select the point coordinates from a list of points saved in the memory
- Select the point coordinates from a CAD drawing with points saved in the memory.

A very efficient method is to enter the check position from the drawing saved in the controller, from which the corresponding two-dimensional or three-dimensional data is extracted.

9.4.2.1 Procedure for “Check with prism” application

1. Check start dialog

To start the “Check” application, press the Check button in the main menu.

Procedure

1. Project selection
2. Station definition and station setup

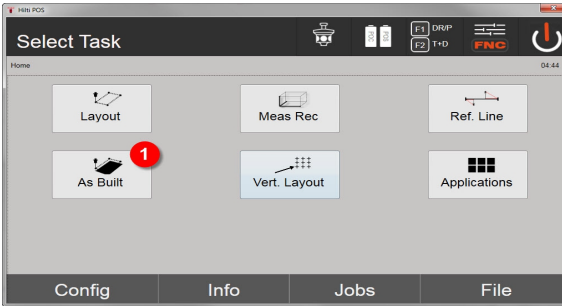

3. Select the “Check” application

2. Check entry dialog

Options for determining the point coordinates for check points

- Enter manually
- Select from a list of saved points
- Select from a CAD drawing with saved points

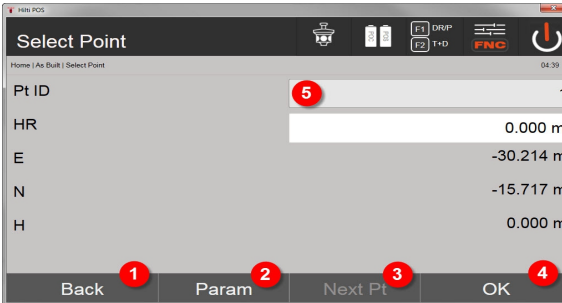

4. Return to previous dialog

5. Enter the layout settings: Sorting criteria for automatic point suggestion, automatic point tracking (on / off), layout tolerances, measuring delay, in order to align the prism rod sufficiently before the distance measurement

6. Select the next point if automatic point suggestion is selected in the settings

7. Confirm the dialog

8. Select points

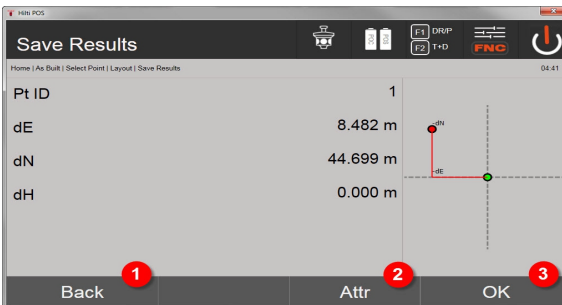

9. Return to previous dialog

10. Enter and display the attributes assigned to the point

11. Confirm dialog and save data



If the option to exclude heights is activated when setting up the station, height values and all associated information are not displayed.

Saving layout data → page 65



Attributes are descriptions of the point and can be taken directly from AutoCAD or Revit together with the point coordinates using **Hilti** Point Creator, or entered manually.

The item number, description, layer, type of graphical element and color of **Hilti** products such as anchors, rails, etc. can be taken from AutoCAD or Revit. The CAD data can contain 2D or 3D data and attributes.

Saving layout data

Product number	Name of layout point
Northings (specified)	The northings entered refer to the coordinate reference system
Eastings (specified)	The eastings entered refer to the coordinate reference system
Height (specified)	Height entered
Northings (measured)	Measured northings refer to the coordinate reference system
Eastings (measured)	Measured eastings refer to the coordinate reference system
Height (measured)	Measured height
dN	$dN = \text{northings (measured)} - \text{northings (entered)}$
dE	$dE = \text{eastings (measured)} - \text{eastings (specified)}$
dH	$dH = \text{height (measured)} - \text{height (specified)}$
Attribute 1 - Attribute 5	Attributes assigned to the point

9.5 Vertical layout (Vert. layout)

9.5.1 The vertical layout principle

In a vertical layout, plan data is transferred to a vertical reference plane such as a wall or facade, etc.

This plan data is either in the form of dimensions that relate to the control line in the vertical reference plane or positions described by coordinates in a vertical reference plane.

The plan data or layout positions in the form of dimensions or distances can be entered with coordinates or can be transferred previously from a PC.

Plan data in the form of CAD drawings can be transferred to the total station from the PC and the applicable graphical point or graphical element for the layout then selected on the total station. This makes working with long numbers or lots of numbers unnecessary.

Typical applications are the positioning of fastening points on facades, installation channels on walls, pipes, etc.

A special application offers the possibility of comparing a vertical surface with a theoretically absolutely flat surface in order to check for unevenness or to produce a record of the results.

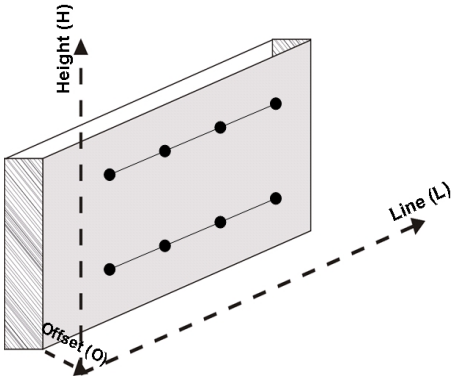

The “Vertical layout” application can be started with the corresponding button in the in the application menu.

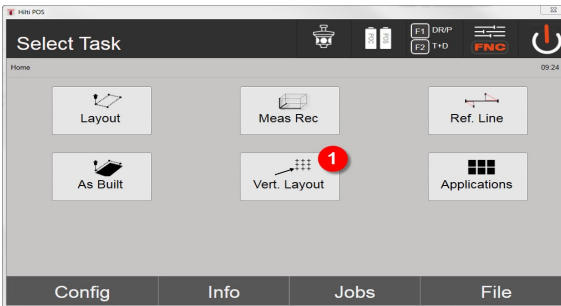

1. Selecting the vertical layout application

After starting the application, the projects or list of projects is shown for selection as well as the corresponding station selection or station setup.

The **Vertical layout** application begins after station setup is completed.

Depending on the station selected, there are two alternative methods for determining the point to be laid out:

2. Laying out points with control lines, i.e. control lines in the vertical reference plane
3. Laying out points with coordinates or points based on a CAD drawing

9.5.2 Vertical layout with control lines

In a vertical layout with control lines, the control lines are defined by measuring to two reference points when the station is set up.

Station setup

The station should be set up in front of the vertical plane in a position that is as central as possible and at a distance that allows as clear a view as possible of all points.

The zero point (1) of the reference axis system and the direction (2) of the vertical reference plane are defined when the tool is set up.

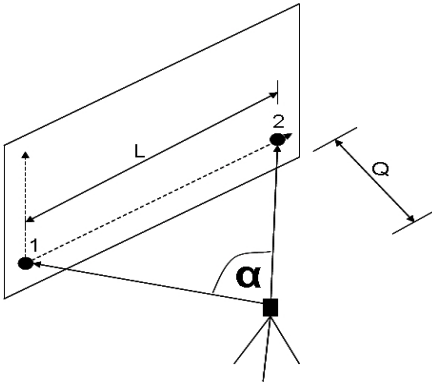

An optimum setup or tool position is when the ratio between the horizontal reference length L and distance Q is $L : Q = 25 : 100$ to $7 : 10$ so that the included angle is $\alpha = 40^\circ - 100^\circ$.

i The procedure for setting up the station is the same as for setting up the station “anywhere” with control lines, with the difference that the first reference point is set at the zero point of the control line system in the vertical plane and the second reference point defines the direction of the vertical plane relative to the tool system. In any case, the horizontal and vertical control lines are adopted from point (1).

Shifting a control line

In order to shift the control line system or the zero point on the vertical reference plane, shift values must be entered.

These shift values can be used to shift the zero point of the control line system to the left (-) and right (+) horizontally, up (+) and down (-) vertically, and the entire plane forwards (+) and backwards (-).

It can be necessary to shift a control line when the zero point cannot be sighted directly as the first reference point. An existing reference point than has to be used and then shifted onto a control line by entering the applicable shift values (distances).

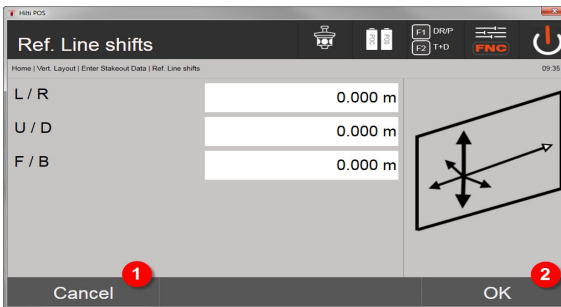

1. Return to control line definition
2. Confirm the shift entries. Continue with entry dialog for longitudinal, lateral and height values.

Entering a layout position

The layout value is entered as a dimension relative to the reference axis or control line in the vertical plane that was defined when the station was set up.

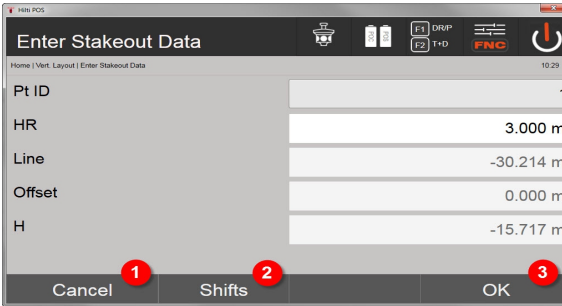

3. Cancel and return to the start menu
4. Enter reference plane shifts
5. Confirm entry and continue, showing display for aligning the tool with the point to be laid out

Direction to the layout point

Using this screen, the tool is aimed at the point to be laid out by rotating the tool until the red direction indicator shows "zero".

The cross hairs are then aimed in the direction of the point to be laid out.

The telescope can then be moved vertically until both triangles are shown as unfilled outlines.



If the upper triangle is solid – move the telescope downwards. If the lower triangle is solid – move the telescope upwards.

Where possible, the person holding the rod can move into position on the sighting line with the aid of the guide light.

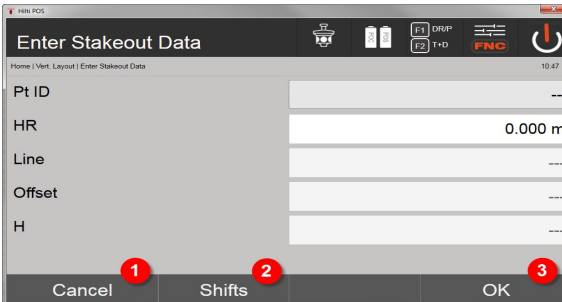

6. Return to entry of layout values
7. Enter reference plane shifts
8. Measure distance and continue, showing layout corrections

Layout corrections

Using the corrections displayed, the target is guided up, down, left, right into position.

With the aid of distance measurement, a correction forward or back can also be made.

The corrections shown are updated after each distance measurement until, step by step, the final position is reached.

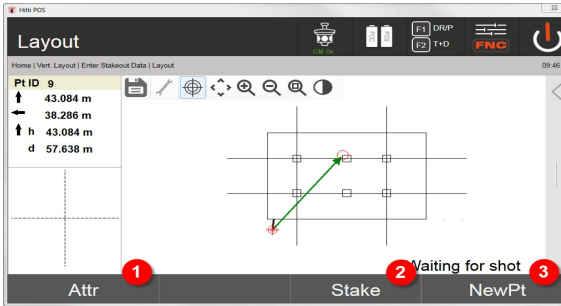

9. Return to entry of layout values
10. Save point
11. Select a new point (not necessary for Smart Layout)

Instructions displayed concerning movement of the target to which measurements are taken → page 69

Layout results

Shows the layout difference in terms of length, height and offset based on the last distance and angle measurements.

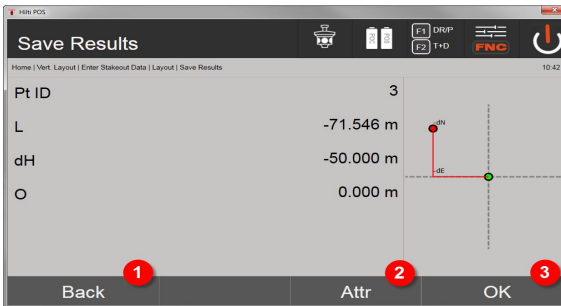

12. Return to entry of layout values
13. Enter attribute values
14. Confirm

Saving data for laying out with control lines → page 69

Instructions displayed concerning movement of the target to which measurements are taken

Fwd	The target must be moved further toward the reference plane.
Back	The target must be moved further away from the reference plane.
Left	The target must be moved further to the left, as seen from the tool, by the amount indicated.
Right	The target must be moved further to the right, as seen from the tool, by the amount indicated.
Up	The target must be moved further up, as seen from the tool, by the amount indicated.
Down	The target must be moved further down, as seen from the tool, by the amount indicated.

Saving data for laying out with control lines

Pt ID	Name of layout point
Line (entered)	Line distance entered, relative to the reference axis
Height (entered)	Height entered

Offset (entered)	Vertical offset entered, relative to the reference plane
Line distance (measured)	Line distance measured, relative to the reference axis
Height (measured)	Measured height
Offset (measured)	Offset measured relative to the reference plane
dL	Difference in line value based on the reference axis DL = line (measured) – line (entered)
dH	Difference in height dH = height (measured) – height (entered)
dOffs	Difference in line value based on the reference axis DO = offset (measured) – offset (entered)

9.5.3 Vertical layout with coordinates

Coordinates can be used, for example, when coordinates are available as reference points and points in the vertical plane are also available as coordinates in the same system.

This is the case, for example, when points in the vertical plane have been measured previously using coordinates.

Entering the layout points

Three different methods can be used to enter layout values with point coordinates:

1. Manual point coordinates
2. Selection of point coordinates from a list of points saved in the memory
3. Selection of point coordinates from a CAD drawing with points saved in the memory

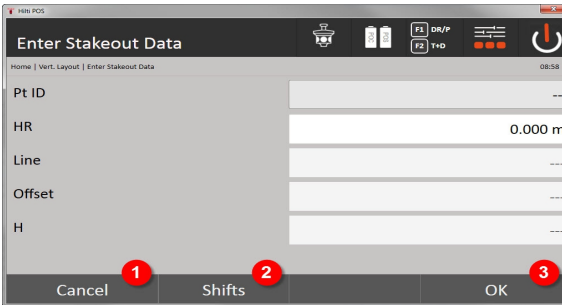

4. Cancel and return to the start menu
5. Enter reference plane shifts
6. Confirm entry and continue, showing display for aligning the tool with the point to be laid out

Entering the layout values (from a CAD drawing)

With this method, the layout points are selected directly from a CAD drawing.

With this method, the point is already incorporated in the drawing as a three-dimensional or two-dimensional point and can be extracted accordingly.

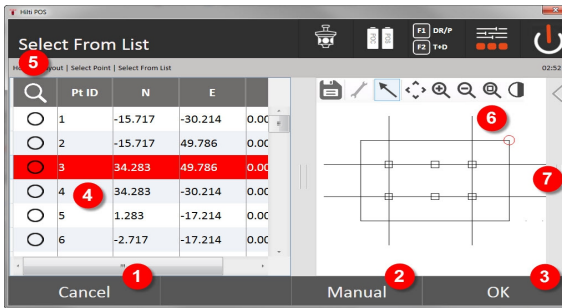

7. Return to previous dialog
8. Enter point manually
9. Confirm the dialog
10. Select points from the list
11. Point search
12. Select points from the drawing
13. Toolbar

Layout results with coordinates

Shows the layout difference in terms of coordinates based on the last distance and angle measurements

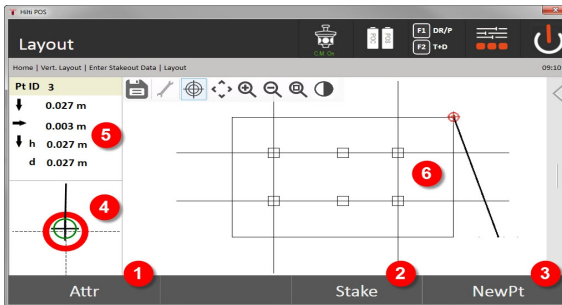

14. Display attributes
15. Save point
16. Select a new point (not necessary for Smart Layout)
17. Display precise layout graphic
18. Directions to the point
19. Graphic display of the prism position

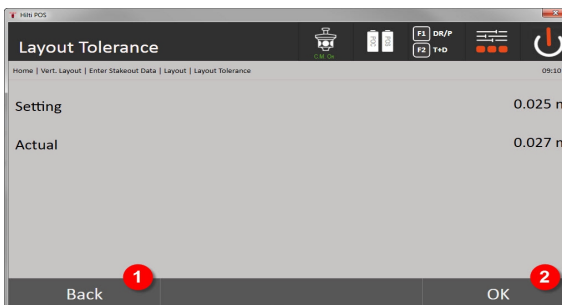

20. Return to previous dialog
21. Confirm the dialog

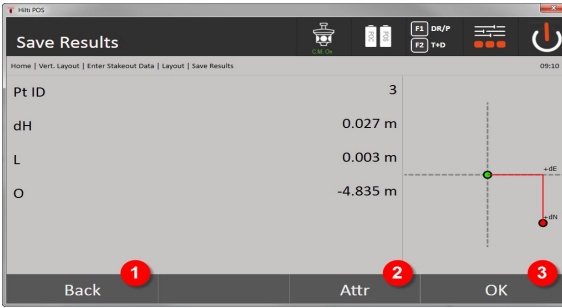

22. Return to entry of layout values

23. Enter attribute values

24. Confirm

Saving data for laying out with coordinates → page 72

The vertical layout always uses three-dimensional point descriptions. In layouts with control lines and layouts with coordinates, the line, height and offset dimensions are used.

The other screens shown are the same as described in the previous section.

Saving data for laying out with coordinates

Product number	Name of layout point
Northings (specified)	The northings entered refer to the coordinate reference system
Eastings (specified)	The eastings entered refer to the coordinate reference system
Height (specified)	Height entered
Northings (measured)	Measured northings refer to the coordinate reference system
Eastings (measured)	Measured eastings refer to the coordinate reference system
Height (measured)	Measured height
dN	dN = northings (measured) – northings (specified)
dE	dE = eastings (measured) – eastings (specified)
dH	dH = height (measured) – height (specified)

9.6 Smart Layout

Smart Layout is an easy way to set out points without having to actively select them. To do this, the function in the parameter dialog must be activated. It will then be available to use in the graphic layout dialog.

After the total station is connected to the prism, the current prism position is shown on the display. The software searches for the point closest to the current prism position and displays this point for the user via direction information. After the point has been reached and set out, the next closest point is automatically selected.

To ensure you can work optimally, we recommend using the layer function to hide all points that are not currently needed for the layout. This prevents points from being unintentionally selected if the prism is closest to these points.

9.6.1 Activating and starting the Smart Layout function

After starting the “Horizontal layout” application, the Smart Layout function (3) can be activated via the parameter function (2).

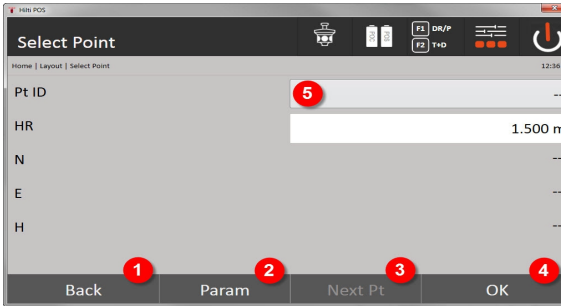

1. Return to previous dialog
2. Set parameters (select Smart Layout)
3. Select the next point
4. Confirm the dialog

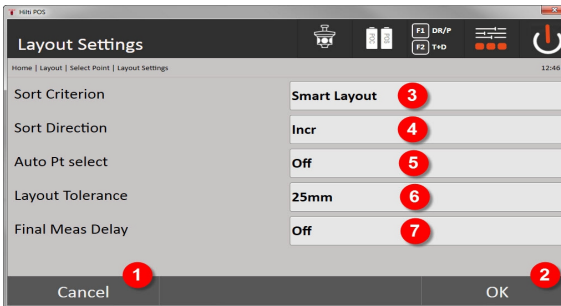

5. Return to previous dialog
6. Confirm the dialog
7. Sorting criterion
8. Sorting sequence (not for Smart Layout)
9. Automatic point selection
10. Layout tolerance
11. Measuring delay

Next, instead of selecting a point in the selection window, close the dialog directly with OK (4).

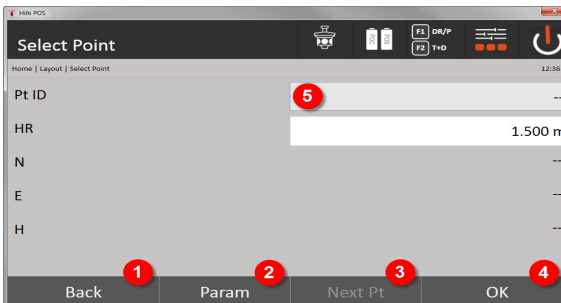

12. Return to previous dialog
13. Set parameters
14. Select the next point
15. Confirm the dialog

The OK (4) button is only active without point selection if the Smart Layout function has been activated

9.6.2 Smart Layout

The following is displayed in the active Smart Layout window:

- Current prisms position with a red circle with cross
- Current position of the total station
- Connection between total station and prism is set up over a line

After the total station is connected to the prism, the closest point to the prism is automatically selected and the direction to this point shown in the top left of the screen (4).

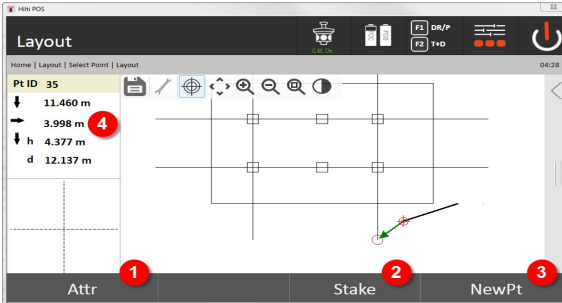

1. Display / enter attributes
2. Lay out / save point
3. Select new point
4. Display showing deviations to the selected point

As soon as the distance drops below 1 m, a dialog is shown in the bottom left-hand corner of the window (5).

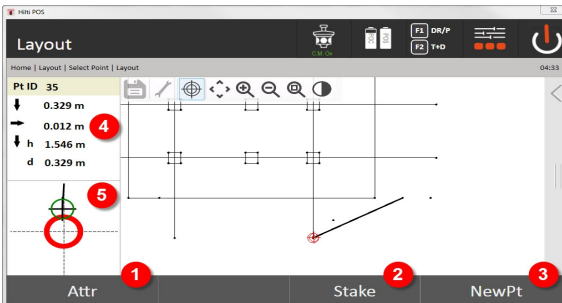

5. Display / enter attributes
6. Lay out / save point
7. Select new point
8. Display showing deviations to the selected point
9. Detailed display of the prism to the selected point

A point can also be selected directly (by selecting the point in the graphic). The Smart Layout function is then deactivated and the software only shows the directions to this selected point, even if other points would be closer to the prism. As soon as the point is deselected, the Smart Layout function is reactivated automatically.

9.7 Applications

The toolbar (6) on the right-hand side of the screen can be brought up using your finger.

The toolbar offers the following functions:

- Extract points from imported CAD files
- Create / delete new points / lines
- Carry out calculations
- Display information
- Show/hide layer(s)

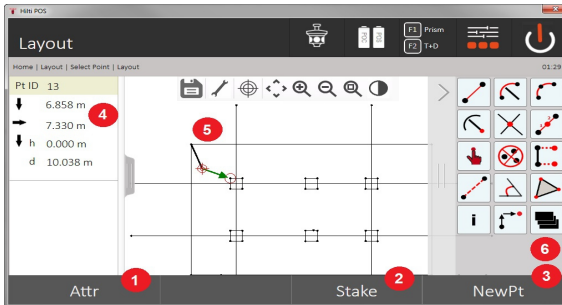

1. Display / enter attributes
2. Lay out / save new point
3. Select new point
4. Display showing deviations to the selected point
5. Graphics window
6. Toolbar

9.7.1 Extracting points

The button to extract points has the following functions:

- Points with and without an offset
- Center points of circles
- Division of a line or line segment
- Create an intersection
- Delete points
- Manual mode



If the function to draw or calculate has been selected, Smart Layout (1) is deactivated.

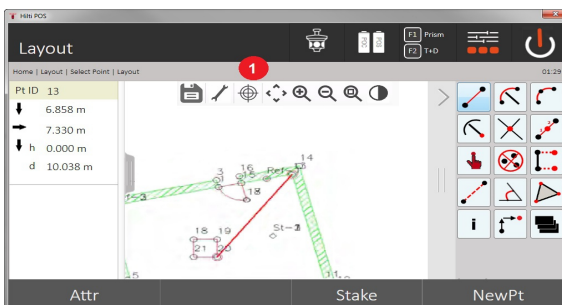

Press the diskette icon (1) to complete the function (Create/delete elements).

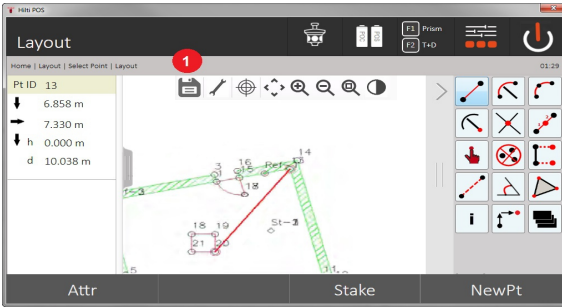

With some functions, there is an option to define additional parameters. If a function allows this option, the symbol (1) is active.

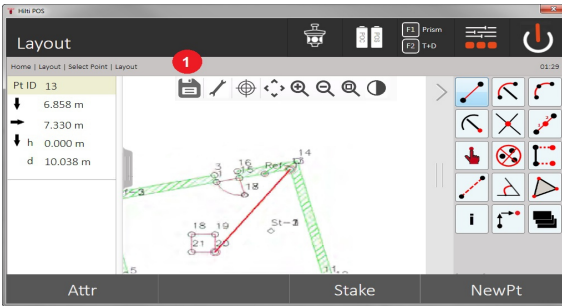

9.7.1.1 Extracting / creating points

	Creates the center point of a radius or curve
	Creates offset points
	Divides a segment of a line or a whole line into sections of equal length
	Creates the intersection of two intersecting lines
	Deletes selected points
	Free selection of points
	Draws a curve comprising three points
	Draws a curve comprising two points and a radius

	Creates a line between two points
--	-----------------------------------

9.7.1.2 Creating offset points

This function lets you enter the point number, longitudinal value and transverse value.

9.7.1.3 Dividing a line or a segment of a line

A segment of a line or a whole line can be divided into sections of equal length.

- The first click selects the whole line.
- The second click selects the segment of the line.
- The third click cancels the selection.

9.7.1.4 Creating a point from a line intersection

Two or more lines that intersect at a point are selected. A new point is created at the intersection. The intersection has no height information.

9.7.2 Drawing

	Draws a curve comprising 3 points
	Draws a curve comprising 2 points and a radius
	Creates a line between 2 points

9.7.3 Carrying out calculations

No connection with the total station is required for use of the CoGo functions.

The following calculations can be performed with the aid of these applications:

- Inverse: Calculation of the azimuth, distance, line and offset, and height difference from given points or elements
- Offsets: Calculation of offset points
- Intersection: Calculation of the intersection of elements
- Angle: Calculation of the angle between elements
- Area: Calculation of area

The calculation is based on:

- Existing points in a job, known distances or known azimuths
- Measured points
- Coordinates entered



If calculations are carried out, more detailed information on the result can be displayed by clicking in the bottom right-hand corner of the screen (1).

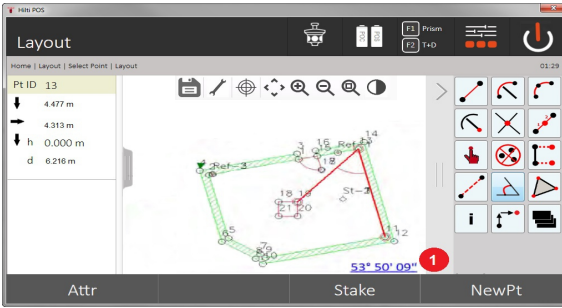

9.7.3.1 Inverse

The following options are available for the calculation:

- 2 points: Azimuth and distance are calculated.
- Line / curve elements: The azimuth and line / curve length are calculated.
- Line / curve element and point: The line / curve length and offset are calculated.

1. Select CoGo “Inverse”



2. Select the elements

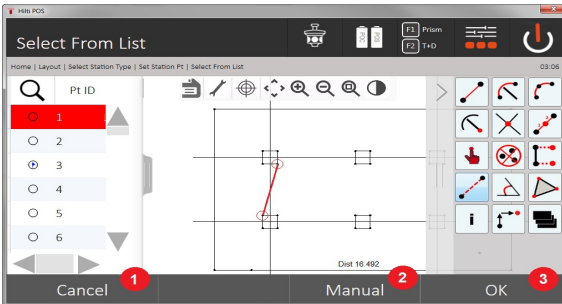

1. Return to previous dialog
2. Manual point entry
3. Close the dialog

In order to start the calculation, the following must be selected:

- Two points or
- one line / one curve or
- one line / one curve and a point

The result is shown directly at the bottom right-hand corner of the screen. If calculations are carried out, more detailed information on the result can be displayed by clicking in the bottom right-hand corner of the screen (2).

3. Result

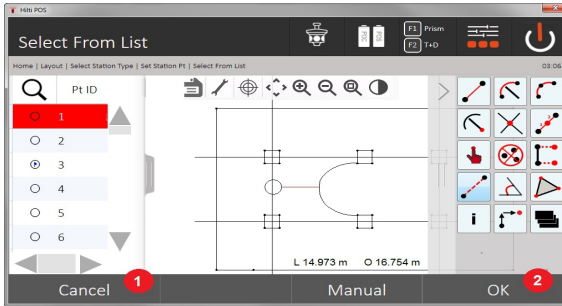

4. Return to previous dialog
5. Close the dialog

9.7.3.2 Offset

Points along lines and curves can be calculated with the aid of the Offset function.

In order to start the calculation, the following must be selected:

- One line or
- one curve.

1. Select CoGo “Offset”

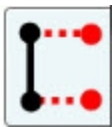

2. Select the element

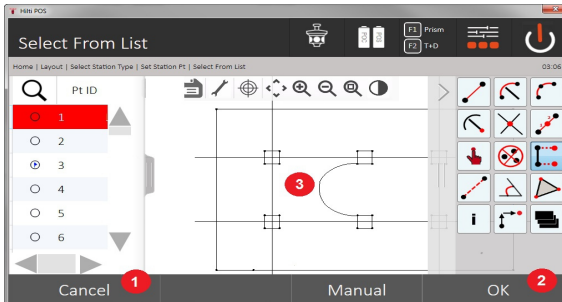

1. Return to previous dialog
2. Confirm the dialog
3. Graphics

In order to start the calculation, the following must be selected:

- One line or
- one curve.

The calculation can then be started with (4).

3. Defining the offsets

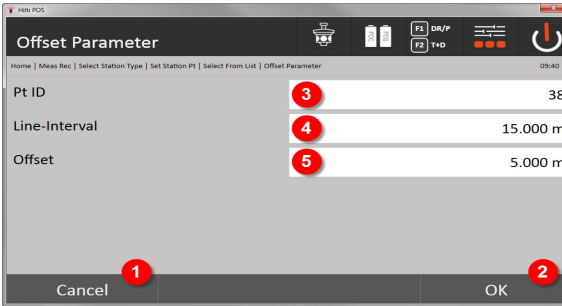

4. Return to previous dialog
5. Confirm the dialog
6. Select starting point
7. Enter the interval
8. Enter offset

4. Displaying the result

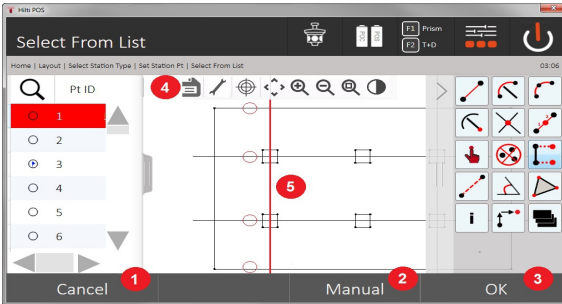

9. Return to previous dialog
10. Confirm the dialog
11. Save the new points
12. Elements with offset points

9.7.3.3 Intersection

The intersection of 2 elements can be calculated with the aid of the “Intersection” function.

In order to start the calculation, the following must be selected:

- Two lines or
- one line and one arc or
- two arcs.

1. Select CoGo “Intersection”

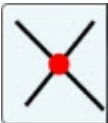

2. Select the element

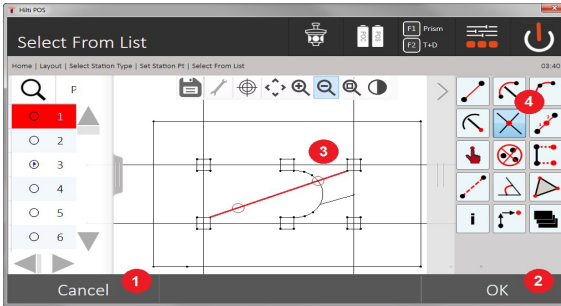

1. Return to previous dialog
2. Confirm the dialog
3. Graphic
4. Toolbar

In order to start the calculation, the following must be selected:

- Two lines or
- one line and one arc or
- two arcs.

The calculation can then be started with (4).

3. Name new points

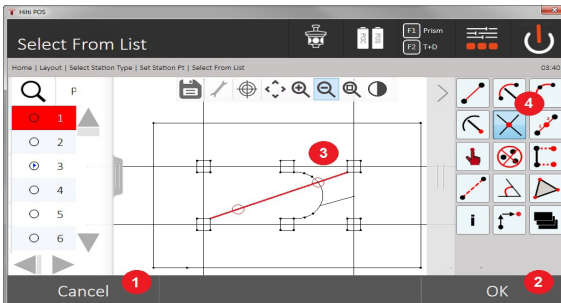

5. Return to previous dialog
6. Confirm the dialog
7. Graphic
8. Toolbar
9. Create an intersection

9.7.3.4 Angle

The angle between two elements can be calculated with the aid of the angle function. In order to start the calculation, three points must be selected.

1. Select CoGo angle

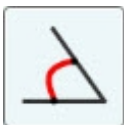

2. Select points

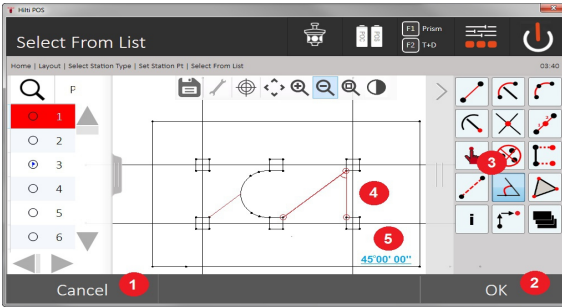

1. Return to previous dialog
2. Manual point entry
3. Confirm the dialog
4. Toolbar
5. Graphic display of results
6. Numerical display of results

In order to start the calculation, three points must be selected.
The calculation can then be started with (4).

3. Display the result



7. Return to previous dialog
8. Confirm the dialog
9. Display the points
10. Display the angle

9.7.3.5 Calculate area

The area can be calculated with the aid of the area function.

In order to start the calculation, at least 3 and no more than 99 points must be selected.

The line is closed automatically when the area calculation is started.

1. Select CoGo area

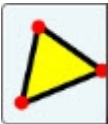

2. Select the element

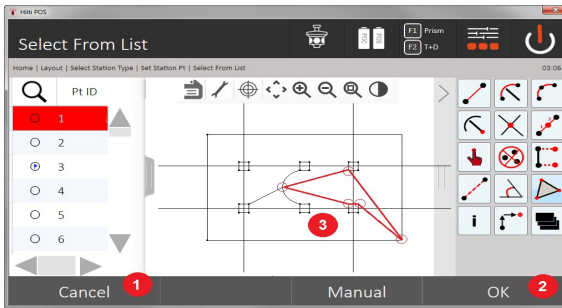

1. Return to previous dialog
2. Confirm the dialog
3. Graphics

A point already selected can be deleted by clicking on it again.

3. Display the result

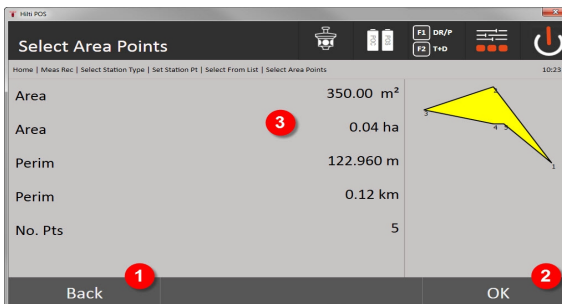

4. Return to previous dialog
5. Save
6. Results are displayed

9.7.4 Layer

With the layer function, it is possible to activate or deactivate individual layers.

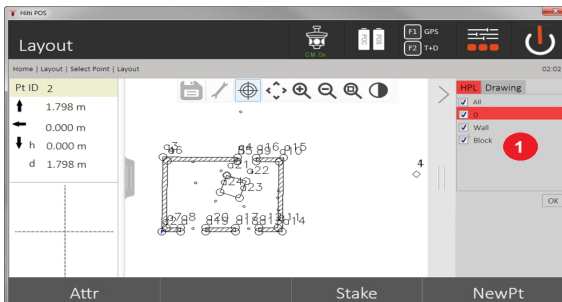

1. A distinction is made between the point / element layers (1) and the imported CAD layers (2). It is thus possible to activate or deactivate points / elements independently of the CAD layers. Deactivated points are not used for the Smart Layout function.



It is not possible to edit or remove layers from the imported CAD file.

9.7.5 Missing line

With the “Missing line” application, two points anywhere within a certain space can be measured in order to determine the horizontal distance, slope distance, height difference and slope or angle between the points. Symbols → page 85

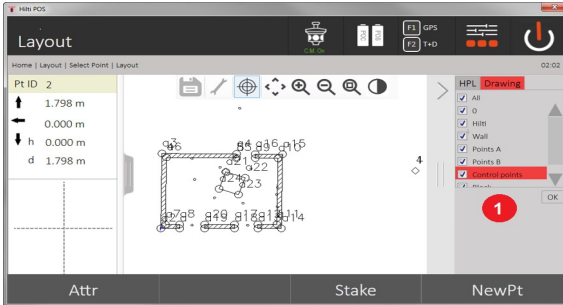

1. Return to previous dialog
2. Confirm the dialog
3. Points / elements from job
4. Points / elements from CAD files

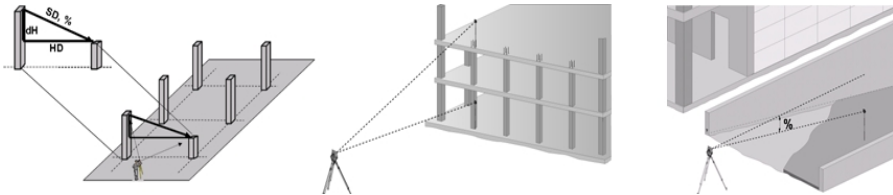

Two different methods can be used to determine the missing line:

- Using the results of measurements between the first and all other measured points
- Using the results of measurements between two measured points

1. Radial missing line relative to base point

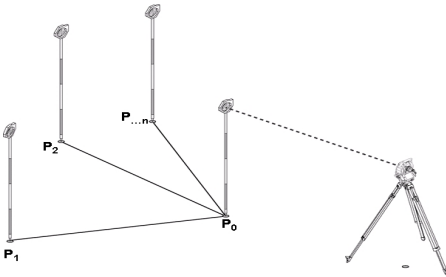

After the first point is measured, all other points measured relate to this first point.

2. Linear missing line relative to first and second point

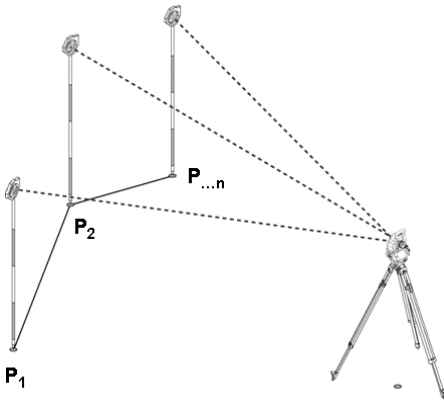

Measure the first two points.

After obtaining the result, choose a new line and a new base point and measure the new second point.

Symbols

	Draws an arc joining three points
	Creates a line between two points
	Draws an arc comprising two points and a radius
	Free selection of points
	Creates a radius or the center point of an arc
	Divides a segment of a line or a whole line into sections of equal length
	Deletes selected points

	Selecting the CAD layer
	Displays all relevant information about the selected object
	Offset point

9.7.5.1 Procedure for “Missing line” application

To start the “Missing line” application, press the Missing line button in the main menu.

1. Missing line start dialog

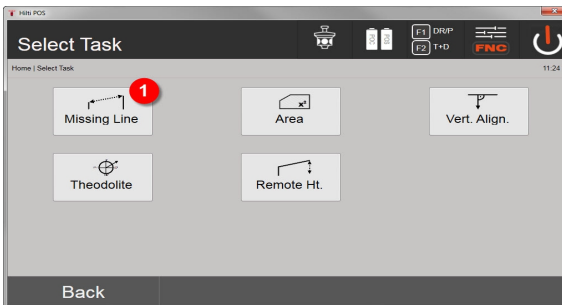

1. Select missing line application

2. Measuring point 1 measuring dialog

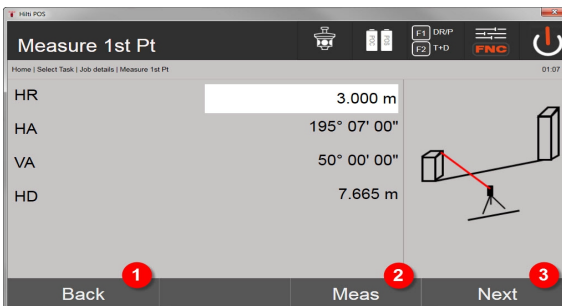

2. Return to project dialog

3. Start measurement

4. Continue to next dialog after measurement

3. Measuring point 2 measuring dialog

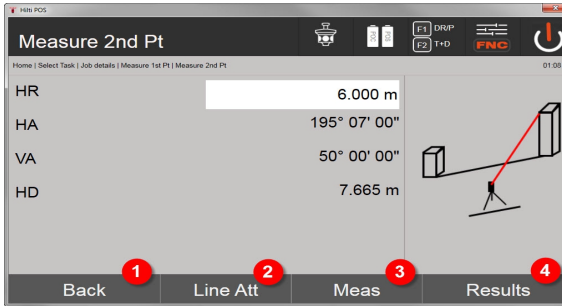

5. Return to previous dialog
6. Enter and display the attributes assigned to the point
7. Start measurement
8. Display results



With the radial missing line, measurement of each additional point (P_n) always relates to the first point (P_0)

With the linear missing line, each new measurement (P_n) relates to the last measured point (P_{n-1}).

Displaying the results and saving data for the “missing line” → page 87

Displaying the results and saving data for the “missing line”

Slope distance	Slope distance between the two last measuring points
Horizontal distance	Horizontal distance between the two last measuring points
Difference in height	Difference in height between the two last measuring points
Inclination %	Inclination in percent (%)
Inclination angle %	Inclination angle in percent (%)

9.7.6 The principle of area measurement

The tool can calculate the horizontal or vertical area enclosed by a total of up to 99 consecutively measured points.

The points can be measured in a clockwise or counterclockwise sequence.

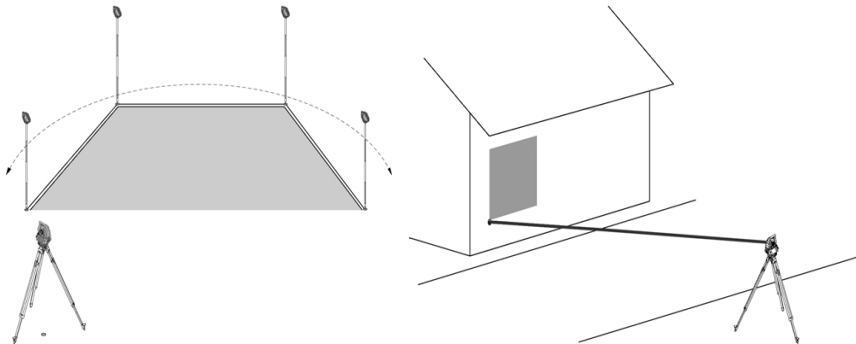

The points must be measured in such a way that the lines between the measured points do not cross each other, otherwise an incorrect area measurement will result.

 The station does not have to be set for this application.

The horizontal area is calculated by projecting the measured points in the horizontal plane.

The points must be measured in a sequence that encloses an area.

For the calculation, enclosure of the area is always completed by an imaginary line between the last measured point and the first measured point.

9.7.6.1 Procedure for “Area measurement” application

To start the “Area measurement” application, press the Area measurement button in the main menu.

1. Area measurement start dialog



1. Select area measurement application

2. Measuring point measuring dialog

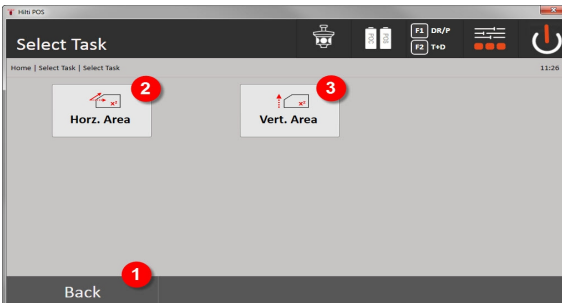

2. Return to previous dialog

3. Horizontal area calculation

4. Vertical area calculation

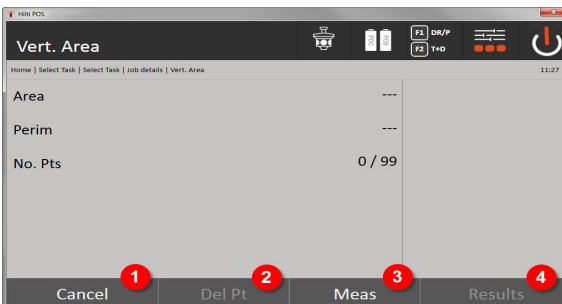

5. Return to previous dialog

6. Delete the last point

7. Measure a point
8. The result is shown

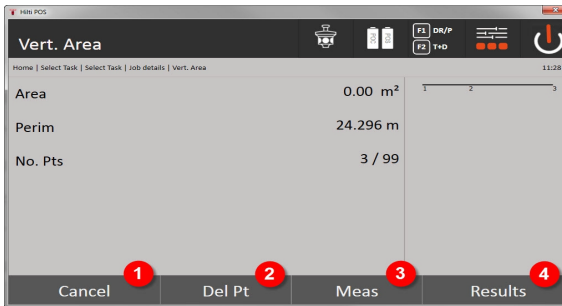

9. Return to previous dialog
10. Delete the last point
11. Measure a point
12. The result is shown

Results

The results are saved in the internal memory and can be displayed on a PC or printed out using **Hilti PROFIS** Layout.

Saving data for area measurement → page 89

Saving data for area measurement

Area	Area in basic units, e.g. m ² , ft ² , etc.
Area	Area in large units, e.g. ha, acre, etc.
Scope	Scope in basic units, e.g. m, ft, etc.
Scope	Scope in large units, e.g. km, miles, etc.
Number of measuring points	Number of measuring points used to calculate the area

9.7.7 Theodolite

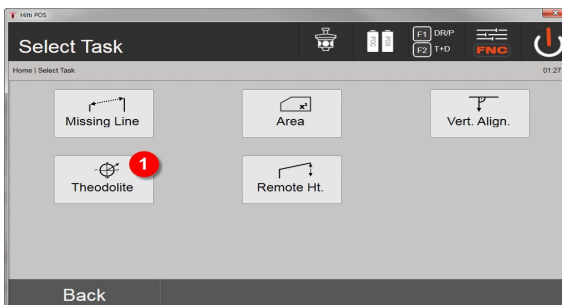

1. Selecting the theodolite application

9.7.7.1 Zeroing the circle reading

The Hz **Zero** option can be used to set the horizontal circle reading to zero quickly and easily.



1. Return to previous dialog
2. Set station
3. Continuous measurement
4. Display the vertical angle in percent
5. Start measurement

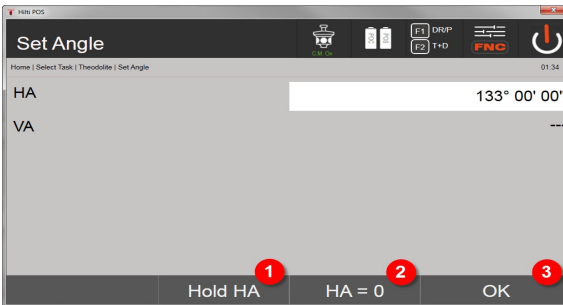

6. Pause current horizontal circle reading
7. Set current horizontal angle to zero
8. Confirm the dialog

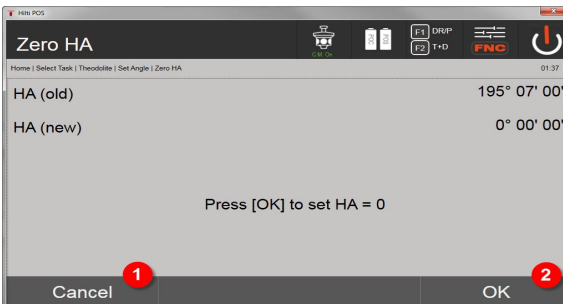

9. Cancel and return to the previous screen without changing the horizontal value
10. Set horizontal value to 0

9.7.7.2 Setting the horizontal circle display

The horizontal circle reading is held, the tool aimed at the new target and the circle reading then released.

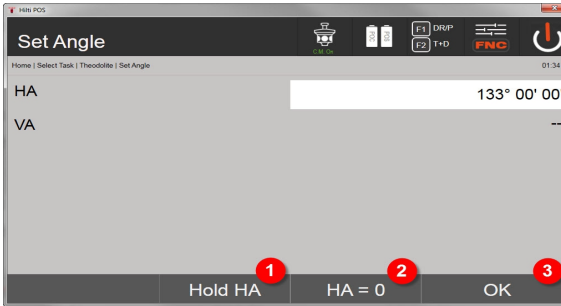

1. Pause current horizontal circle reading
2. Set current horizontal angle to zero
3. Confirm the dialog

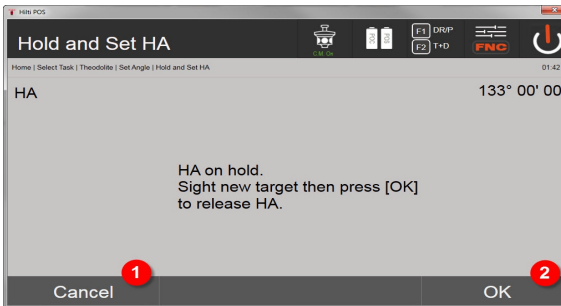

4. Cancel and return to the previous screen without changing the horizontal value
5. Set horizontal value in the display

9.7.7.3 Entering a circle reading manually

Any desired circle reading can be entered manually in any position.

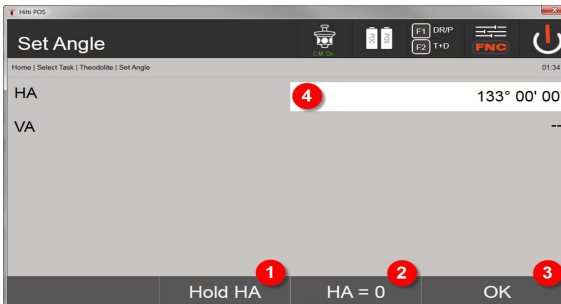

1. Pause current horizontal circle reading
2. Set current horizontal angle to zero
3. Confirm the dialog
4. Enter the horizontal angle value manually

9.7.7.4 Inclination indicator

Each vertical circle reading can be shown in degrees or in percent.



1. Toggle vertical angle display between degrees and percent

9.7.8 Indirect height measurement

9.7.8.1 The principle of indirect height measurement

The indirect height measurement method is used to determine the height difference to inaccessible objects or points in situations where direct distance measurement is not possible.

Virtually any height or depth, e.g. heights to the extremities of a crane, the depth of an excavation or heights in many other similar situations can be determined using the indirect height measurement method.

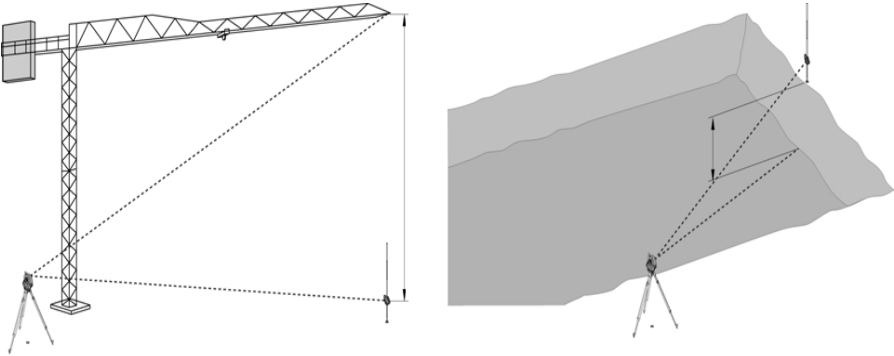

It is essential that the reference point and the other inaccessible points all lie in the same vertical plane.

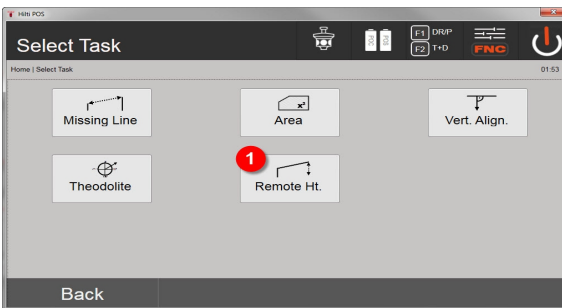

1. Select the indirect height measurement application

After selecting the application, the list of projects is displayed.

The station does not have to be set for this application. The station does not have to be set for this application.

9.7.8.2 Indirect height measurement

Measurements to the 1st reference point

An angle and distance measurement to the 1st measuring point is taken.

The distance can be measured directly to the point or using the reflector rod, depending on ease of access to the 1st reference point.

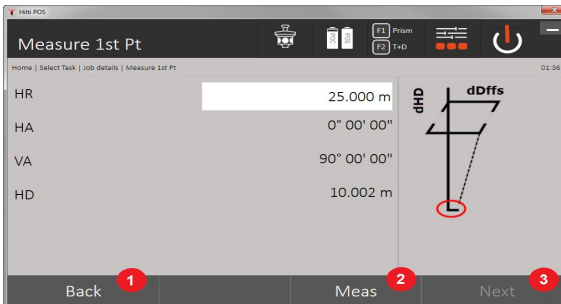

1. Return to project selection
2. Start measurement to point
3. Continue to the next measurement

Measuring to other points

Measuring to other points is carried out simply by measuring the vertical angles. The difference in height relative to the 1st reference point is indicated continuously.

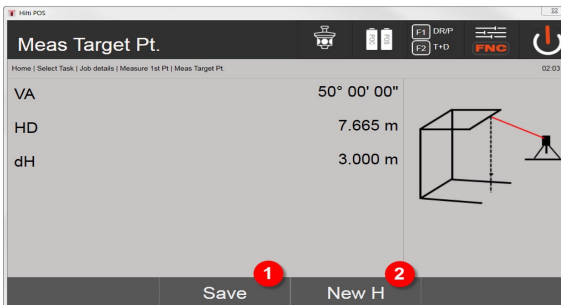

4. Save results
5. New (additional) indirect height measurement based on a new reference point

9.7.9 Vertical alignment

9.7.9.1 The principle of the vertical alignment mode

Vertical alignment can be used to check that objects are vertical or to transfer vertical lines.

We would like to point out the advantages of this system for setting up formwork for columns in the vertical plane or for laying out or checking points that lie vertically one above the other over several floors of a building.

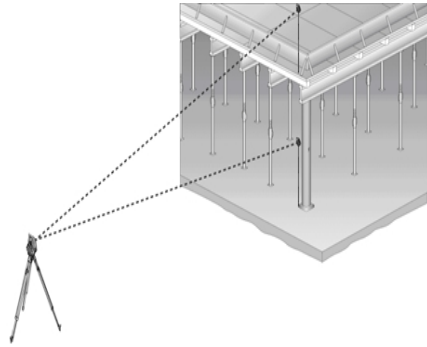
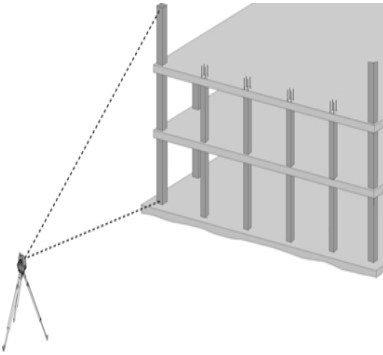

i In principle, two measured points are checked in order to determine whether they lie vertically one above the other.

i Depending on the needs of the application, the measurements can be made with or without use of a reflector rod.

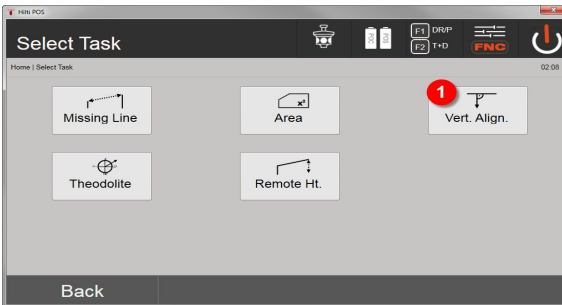

1. Select the vertical alignment application
After selecting the application, the list of projects is displayed.
The station does not have to be set for this application.

Measurements to the 1st reference point

An angle and distance measurement to the 1st measuring point is taken.
The distance can be measured directly to the point or using the reflector rod, depending on ease of access to the 1st reference point.

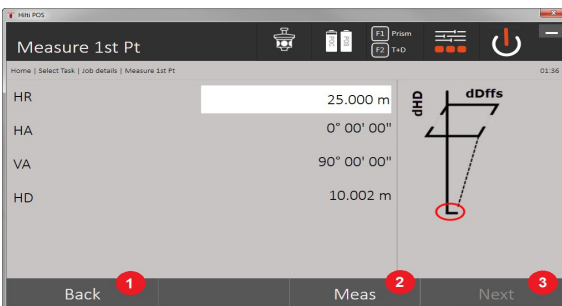

1. Return to project selection
2. Start measurement to point
3. Continue to the next measurement

Measuring to other points

The other points are always determined by taking angle and distance measurements.

After the second and each further measurement, the correction values compared to the 1st reference point are updated in the display below.

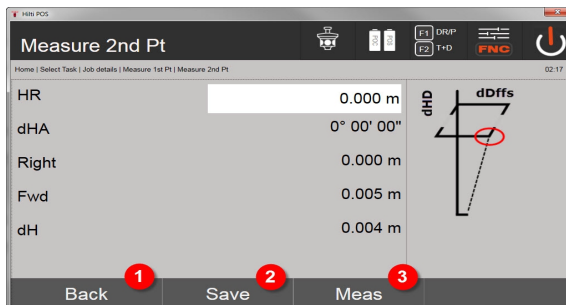

4. Return to "Measuring to the first reference point"
5. Save results
6. Measure angle and distance and update correction values in the display

10 Data and data handling

10.1 Introduction

Hilti total stations always save data in an internal memory.

The data consists of measured values, i.e. angles and distances or, depending on settings or the application, values relating to the control line such as longitudinal and lateral values or coordinates.

With the aid of PC software, data can be exchanged with other systems.

In principle, all total station data should be regarded as point data, with the exception of graphical data in which the points are incorporated.

The applicable points are available for selection and use, but not the graphics data itself, which simply provides additional information.

10.2 Point data

Point data can consist of new measured points or existing points. The total station basically measures angles and distances.

The station setup allows target point coordinates to be calculated.

Accordingly, each point that has been sighted with the cross hairs or laser pointer and the distance to it measured is calculated by the total station as a three-dimensional point.

These three-dimensional points are clearly identified by point designations.

A point designation, a Y-coordinate, an X-coordinate and possibly a height are given for each point.

Given points are defined by their coordinates or points with graphical elements.

10.2.1 Points in the form of measured points

Measurement data takes the form of measured points generated and saved in the memory as coordinate points on the total station by the relevant application, e.g. Horz. Layout, Vert. Layout, Check and Measure and Record.

Measured points exist only as a single instance within a station.

If the same name is used again for a measured point, the existing measured point can be overwritten or another point name assigned to it.

Measured points cannot be edited.

10.2.2 Points in the form of coordinate points

When working with the coordinate system, all positions are, as a rule, defined by a point name and coordinates – at least a point name and two horizontal coordinates X, Y or E, N are necessary to describe a point position.

The height is generally independent of the XY coordinate values.

The total station uses points in the form of coordinate points – so-called control points or fixed points and measured points with coordinates.

Fixed points are points with given coordinates which have been entered manually on the total station or transferred with **Hilti PROFIS Layout** using a USB mass storage device or directly via the USB data cable.

These fixed points may also be layout points. A control point (fixed point) in a project is unique (the only one). Control points or fixed points can be edited on the total station so long as no graphical element is attached to the point.

10.2.3 Points with graphical elements

Using **Hilti PROFIS Layout**, graphical data can be loaded from a CAD application, shown and selected on the tool.

The **Hilti** system enables points and graphical elements to be created in various ways using **Hilti PROFIS Layout** and for these to be transferred to or used on the total station.

Points with attached graphical elements cannot be edited on the total station, but can be edited on the PC using **Hilti PROFIS Layout**.

10.3 Generation of point data

10.3.1 With the total station

Each measurement taken generates a measurement data set or, respectively, a measured point. Measured points are defined either only as angle and distance values, point name with angle and distance values or as point name with coordinates.

10.3.2 With Hilti PROFIS Layout

1. Generating points from a model consisting of lines and curves shown with graphical elements

With the **Hilti PROFIS Layout** PC application, dimensions from the building plan can be used to generate a graphical layout which is a reproduction, so to speak, of the building plan.

With the aid of this application, the plan is reproduced in simplified graphical form on the PC, resulting in lines and curves, etc. on a graphical background.

In doing so, specific curves can be created, from which points can be generated, e.g. at regular intervals.

2. Generating points from imported CAD and CAD-compatible data

With the aid of **Hilti PROFIS Layout**, CAD data in DXF format, or in AutoCAD-compatible DWG format, is transferred to the PC.

Points are then generated from the graphical data, i.e. lines, curves etc.

In **Hilti PROFIS Layout**, using CAD graphics, it is possible to generate point data from end points, line intersections, mid points of line segments and points on circles, etc.

The point data generated in this way is placed visibly on the original graphics elements from CAD.

The data in a CAD format can exist in various "layers". When this data is transferred to **Hilti PROFIS Layout** it is merged into a single layer.



When organizing the data on the PC before it is transferred to the tool, special care must be taken to ensure that the "density" of the point data is as to be expected in the final result.

3. Importing point data from tables or text files

Point data can be imported into **Hilti PROFIS Layout** from text or XML files and then transferred to the total station.

10.3.3 With Hilti Point Creator

The **Hilti Point Creator** software is a plug-in which can be installed in AutoCAD from version 2010. Using **Hilti Point Creator**, points are extracted from 2D and 3D drawings. In addition, descriptions (attributes) for these positions are taken from the AutoCAD 2D/3D model. The attributes are taken from **Hilti** products – see the **Hilti BIM/CAD** library. For **Hilti** products, the **Hilti** product item number, product designation and product type are taken. In addition, more general attributes are taken, such as layer name and color of the graphic element in the AutoCAD model.

Point data can be created directly from 2D or 3D CAD models. This point data is exported from the AutoCAD software with the help of **Hilti Point Creator** in various formats.

Hilti Point Creator output formats for points

- Text format with attributes (.txt)
- Excel format with attributes (.csv)
- CAD format; only points without attributes (.dxf)

- **Hilti** data format with attributes (.oml)

10.4 Data memory

10.4.1 Total station internal memory

The **Hilti** total station saves and organizes application data correspondingly in memory. Point or measurement data is organized in the system according to projects and stations.

Project

A single block of control points (fixed points) or layout points belongs to a project.

A number of stations may belong to a project.

Tool station plus orientation (where relevant)

A station must always have an orientation.

Measured points with unique point designations belong to a station.



A project can essentially be regarded as a file.

10.4.2 USB mass storage device

USB mass storage device allows data to be transferred between a PC and the total station. It is not used as additional main memory.



The total station's internal memory is always used as its active main memory.

11 Total station data manager

11.1 Overview

The Data Manager provides access to the data stored in the controller's internal memory.

Options for the Data Manager:

- Import and export data
- Display, create, delete projects
- Display, create, delete, edit fixed points plus display, delete measuring points
- Display, create, delete graphic, edit graphic elements such as lines, curves

11.2 Procedure for "Data Manager" application

Access to data management is directly from the start screen.

1. System start dialog

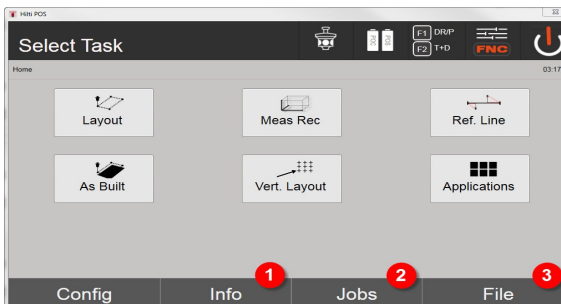

1. Information about the project
2. Select Project Manager
3. Select Import/Export Manager

2. Info start dialog

- Import/Export Manager (import/export of point data)
- Project Manager (display, create, delete project options)

- Point Manager (display, create, delete, edit fixed points plus display, delete measuring points)
- Graphic Manager (display, create, delete lines and curves) de 89

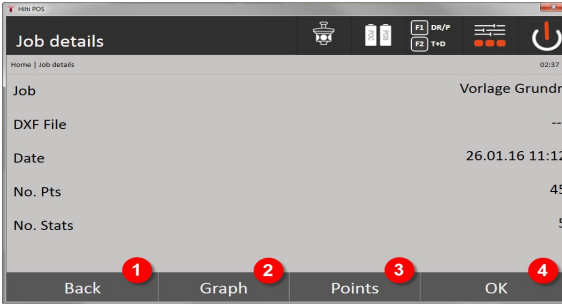

4. Return to previous dialog
5. Select graphic display
6. Select Point Manager
7. Confirm the dialog

11.2.1 Import/Export Manager

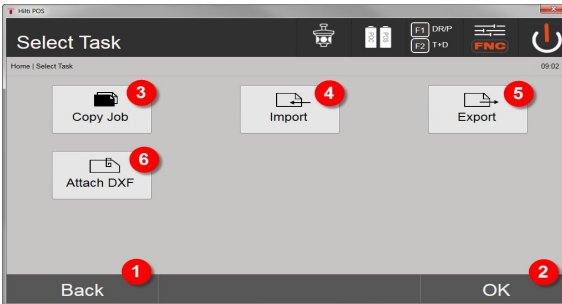

1. Return to previous dialog
2. Confirm copying of data to the internal memory
3. Copy data
4. Import data option
5. Export data option
6. Import .dxf file option

11.2.1.1 Import points

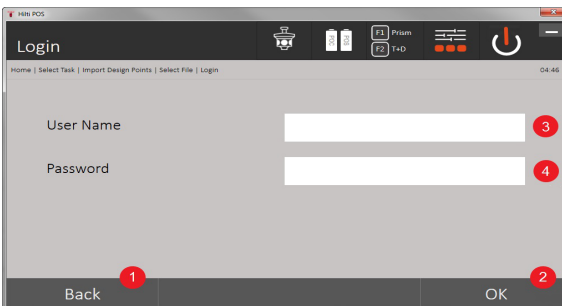

1. Return to previous dialog
2. Confirm the dialog
3. Type your user name

4. Type your password

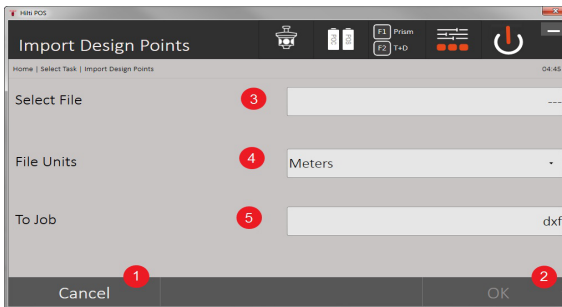

1. Return to previous dialog
2. Confirm the dialog
3. Select the file to be imported
4. Define the units used by the file to be imported
5. Define the target folder

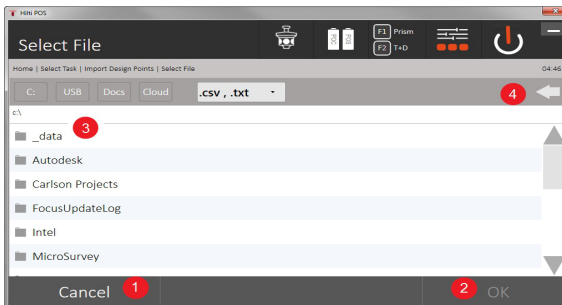

1. Return to previous dialog
2. Confirm the dialog
3. Select the file to be imported
4. Return to previous folder

This option is used to load data from the connected USB data storage device directly into the selected project. All points with coordinates are imported as fixed points, i.e. the points can be used for positioning, setting out and for the graphics (lines, arcs). During the import process, the point numbers of the points are compared with the point numbers that already exist in the project.

As each point number can occur only once as a fixed point within a project, the following four options are available for dealing with point-number matches:

Selection options for point-number matches

- Do not overwrite existing individually selected points
- Overwrite existing individually selected points
- Do not overwrite existing points
- Overwrite all existing points

Data can be imported in .csv or .txt file format. The individual data elements must exist in the above-mentioned sequence. The following elements are imported as fixed point data in this sequence: Pt. no., N(X), E(Y), H(Z), attributes 1-5.



Points that do not exist in the project are imported without user notification. Further elements that exist after the specified imported elements, if any, are ignored.

11.2.1.2 Export points

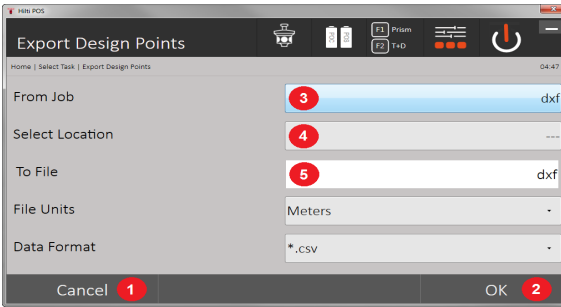

The export function exports all points of a project to a connected USB data storage device, and all points are considered as being the same. Any name can be assigned to the export file. The data elements exported differ, depending on the point type in a project:

1. Return to the previous dialog
 2. Confirm the dialog
 3. Select the point export source
 4. Select the point export target
 5. Define the file format
- Export fixed points with: Pt. no., N(X), E(Y), H(Z), attributes 1 – 5
 - Export measured points with: Pt. no., N(X), E(Y), H(Z), attributes 1 – 5, HA, VA, HD, hr, ppm

 A unique name must be assigned to each file of a file type. If the same name is entered again for a file of the same type, the existing file will be overwritten, i.e. deleted.

 Measured points can be converted into fixed points by being exported and subsequently re-imported.

11.2.1.3 Internal copying of data

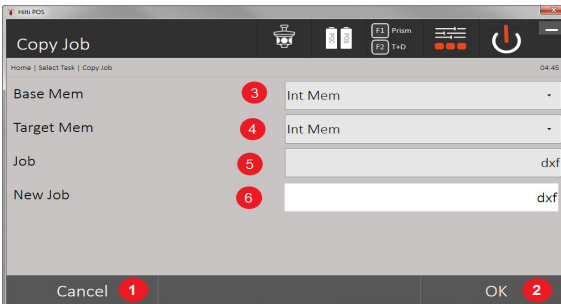

This option can be used to duplicate a project in internal memory. All project data are saved under a new name.

1. Return to previous dialog
2. Confirm the dialog
3. Select the file to be exported
4. Select the target for the copy operation
5. Select the source to be copied
6. Assign new project name

11.2.1.4 Importing / attaching a .dxf or .dwg file

This option lets you import a .dxf or a .dwg file into a project or attach it to a project.

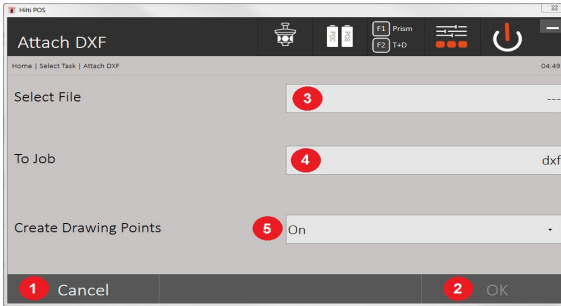

1. Cancel the dialog
2. Confirm the dialog
3. Select a project
4. File format of imported file
5. Activate automatic point extraction

11.2.2 Project Manager

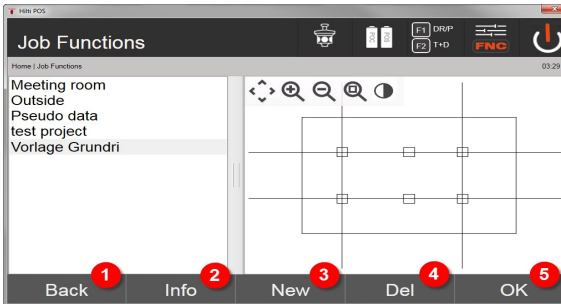

1. Return to Data Manager start dialog
2. Project information
3. Set up new project
4. Remove project
5. Set marked project as current project

11.2.3 Point Manager

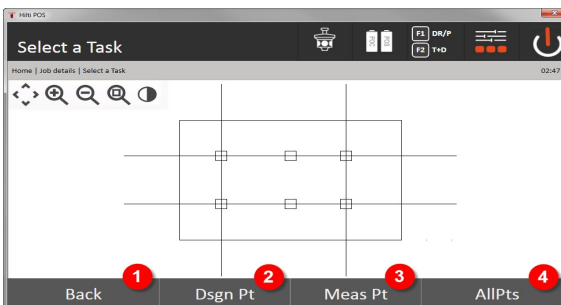

1. Return to Data Manager start dialog
2. Fixed points option
3. Measuring points option
4. Display all points option

11.2.3.1 Fixed points

Fixed points can be displayed, deleted, edited and re-entered. When new fixed points are entered, in addition to the point numbers and coordinates, up to an additional five descriptions (attributes) can also be entered.

Data elements of fixed points

- Point no.
- N
- E
- H(Z)
- Attributes 1 – 5



Fixed points which have a graphic element assigned to them, e.g. line, curve etc., can only be deleted when the graphic element has been deleted.

11.2.3.2 Measured points

Measuring points are always assigned to a station. Once a station has been selected, all measuring points for this station can be displayed and deleted.

Options for deleting measuring points

- Each measuring point can be individually deleted once the station is selected
- All measuring points can be deleted at the same time by deleting the station



Particular care should be taken when deleting measuring points. For example, if a station is deleted and therefore all the attached measuring points, many measuring hours or a day's work can be lost.

Data elements of measuring points

- Pt. no.
- N(X)
- E(Y)
- H(Z)
- Attributes 1 – 5
- HA
- VA
- HD
- hr
- ppm



For a selected measuring point, the assigned attributes can be displayed from the application "Measure and Record".

Measuring points can be used for setting the station and orientation, but not for assigning graphic elements, for example lines and curves for the "Reference line" application.

11.2.3.3 Targeting

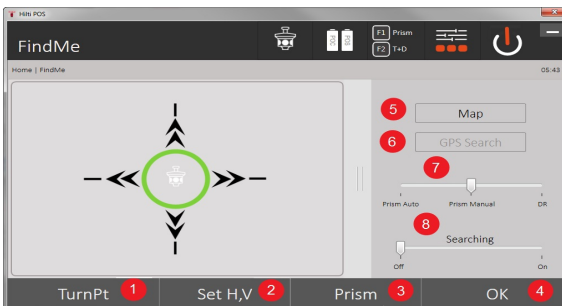

All fixed points and all measured points are displayed here, sorted by point number, with the corresponding type designation (fixed point or measured point). The points can be viewed in a diagram, in a list or one after the other.

1. Rotate the device to select the point
2. Set the HA and VA
3. Select the prism
4. Confirm the dialog
5. Change the perspective of the top view
6. Switch to GPS search
7. Select the measuring mode
8. Start the automatic prism search

The "Targeting" dialog helps you find the prism

There are 3 different modes:

9. Joystick – Use the joystick on the display.
Alternatively, you can use the buttons at top right to make the settings.
10. Top view – Select a point.
Alternatively, you can select a white surface in the top view.
The tool brings itself into alignment and the VA is set automatically to 90°.
11. Prism search – Select prism search.
Select **search for target**.
The tool aligns itself with the POC 200.



The prism search works only when a GPS signal is received and the prism was locked (10 sec - 2 min).

12 Data exchange

12.1 Introduction

Options for the data exchange between the total station system POS 150 / 180 and the PC

- Connection with the **Hilti PROFIS Layout** PC program
The data is exchanged in binary format and cannot be read without these programs. Data can be exchanged using either the USB data cable supplied or a USB mass storage device (e.g. flash drive).
- USB data storage device
With the USB data storage device, files in .csv and .txt format can be exchanged directly from the controller both for data import and data export.

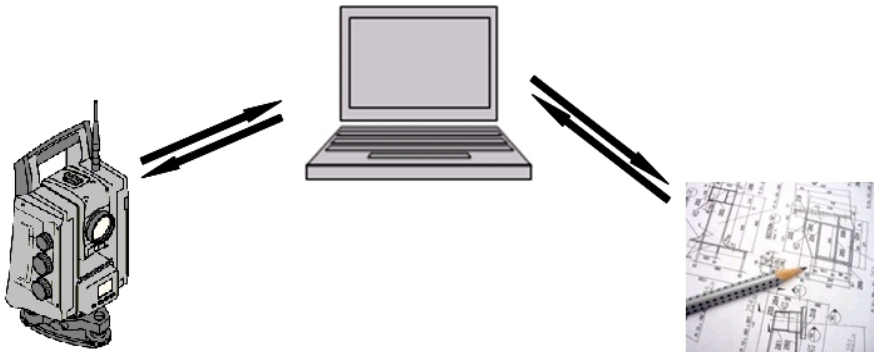

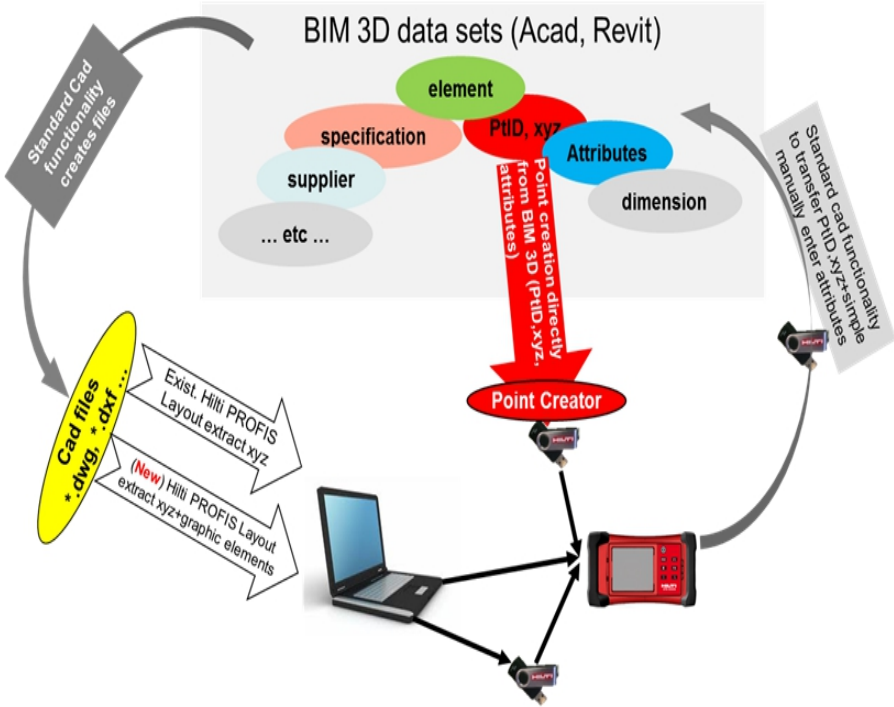

12.2 Hilti PROFIS Layout

Data is always exchanged as a complete project, i.e. all data belonging to a project is exchanged between the **Hilti** total station and **Hilti** PROFIS Layout.

A project may contain only control points or fixed points, with or without graphics, or a combination, i.e. control points or fixed points and measured points (measurement data) including results from the corresponding applications.

12.2.1 Data types

Point data (control points or layout points)

Control points are, at the same time, also layout points, to which graphical elements can be attached in order to facilitate identification or to describe the situation.

If these points with graphical elements are transferred from a PC to the total station, then this data will be displayed with graphics on the total station.

If control or layout points are entered manually on the total station at a later point in time, no graphical elements can be assigned or added to these on the total station.

Measurement data

Measuring points or, respectively, application results can always only be transferred from the total station to Hilti PROFIS Layout.

The measuring points transferred can take the form of point data in space-separated, comma-separated (.csv) text format or in other formats such as .dxf and AutoCAD-.dwg, and can be processed further on other systems.

Application results such as layout differences, area results, etc. can be output in text format as reports by Hilti PROFIS Layout.

Summary

The following data can be exchanged between the total station and **Hilti** PROFIS Layout in either direction.

Data exchange from the total station to Hilti PROFIS Layout

- Measurement data: Point name, angle and distance

- Point data: Point name, coordinates and height

Hilti PROFIS Layout to the total station

- Point data: Point name, coordinates and height
- Graphics data: Coordinates with graphical elements



No provision has been made for direct data exchange between the total station and other PC systems; this can be done only by using Hilti PROFIS Layout.

12.2.2 Hilti PROFIS Layout data output (export)

Data is saved in the following applications and can be output in various formats using Hilti PROFIS Layout:

Hilti PROFIS Layout output formats

- Horizontal layout
- Vertical layout
- Check
- Measure and record
- Area measurement (calculation)

Data output

Hilti PROFIS Layout reads the data saved by the total station and extracts the following data.

Extracted data

- Point name, horizontal angle, vertical angle, distance, reflector height, tool height
- Point name, E(Y) coordinate, N(X) coordinate, height
- Application results such as differences in layouts and area measurements

Output formats → page 105

Output formats

CSV format	Comma-separated values.
Text format	Gaps between data filled with spaces so that individual data items appear in columns.
DXF format	Text exchange format compatible with CAD.
DWG format	AutoCAD compatible binary data format.

12.2.3 Hilti PROFIS Layout data input (import)

Data input

Hilti PROFIS Layout can read the following data, convert it and transfer it to a USB mass storage device or via a cable to the total station:

- Point names (fixed points) with coordinates and heights.
- Polylines (lines, curves) from other systems

Input formats → page 105

Input formats

CSV format	Comma-separated values.
txt format	Space-separated values.
Text format	Gaps between data filled with spaces so that individual data items appear in columns.
DXF format	CAD drawing with lines and curves as general CAD data exchange format.
DWG format	CAD drawing with lines and curves as format compatible with AutoCAD

12.3 Hilti Point Creator

The Hilti Point Creator software is a plug-in which can be installed in AutoCAD from version 2010. Using Hilti Point Creator, points are extracted from 2D and 3D drawings. In addition, descriptions (attributes) for these positions are taken from the AutoCAD 2D/3D model. The attributes are taken from Hilti products – see the Hilti BIM/CAD library. For Hilti products, the Hilti product item number, product designation and

product type are taken. In addition, more general attributes are taken, such as layer name and color of the graphic element in the AutoCAD model.

12.3.1 Overview of the functions available in Hilti Point Creator

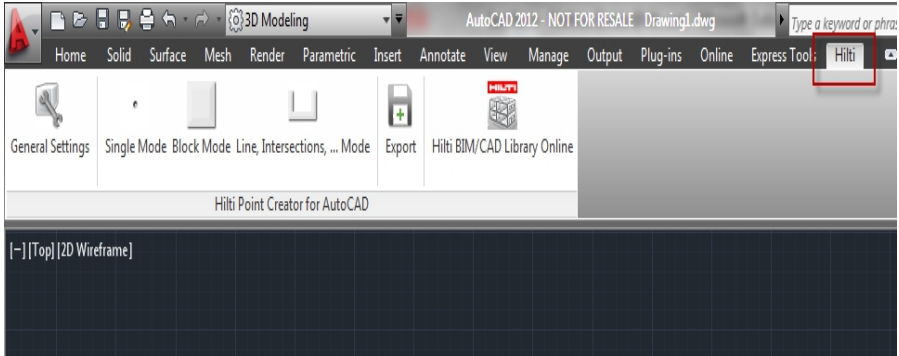

Hilti Point Creator offers the following functions:

Settings

- General settings

Data import

- Imports points according to the settings from various data formats.

Point selection methods

- Single mode
Individual points are determined using the AutoCAD capture function
- Block mode
Takes points from blocks. These points are first “learned” in a reference block.
- Line mode
Determines points from elements such as lines or curves. The points are determined either from their ends or middle or from the intersection of curves and lines, the intersection of lines with lines or from the intersection of curves with curves.

Data export

- Exports the extracted points in accordance with the settings in various output formats

Link to the Hilti BIM/CAD Library

- Loads Hilti BIM/CAD objects from the Internet and inserts them into AutoCAD or Revit or other design software.

The created points with attributes are assigned a point designation. These are copied on a layer defined by the user (Hilti is standard) and can be output in various data formats.

Help

- Displays help and information about the program version.

Hilti Point Creator output formats for points

- Text format with attributes (.txt)
- Excel format with attributes (.csv)
- CAD format only points without attributes (.dxf)
- Hilti data format with attributes (.oml)

Typical data created by Hilti Point Creator (.txt, .csv):

PtID	N(x)	E(y)	Height	Layer	Item No	Naming	Element	Color
Ins_1	2024.597	72.509	3.056	Pipe 15	285927	HIL-23	INSERT	white
Ins_2	2020.597	72.509	3.056	Pipe 15	285927	HIL-24	INSERT	white
Ins_3	2016.597	72.509	14.234	Pipe 16	285927	HIL-25	INSERT	white
Ins_4	2012.597	72.509	14.230	Pipe 17	285927	HIL-26	INSERT	white
Ins_5	2008.597	72.509	14.000	Pipe 18	285927	HIL-27	INSERT	white
Ins_6	2004.597	72.509	1.002	Water	285927	HIL-28	INSERT	white
Ins_7	2004.245	73.371	1.100	Water	285927	HIL-29	INSERT	white
Ins_8	2004.245	75.772	1.345	Water	285927	HIL-30	INSERT	white
REF_1	2025.837	72.89	1.632	Control Pts		Inside Ref	Ref Tape	black
REF_2	2002.445	77.59	1.724	Control Pts		Inside Ref	Prism	black
REF_3	1971.17	71.918	1.773	Control Pts		Inside Ref	Ref Tape	black

13 Data connection with RS 232

The **Hilti** total station is equipped with an RS 232 interface to which a data logger can be connected for data transfer. Please contact your Hilti representative for further information.

14 Calibration and adjustment

14.1 Calibration review

The tool is correctly adjusted when supplied. The values to which the tool is set may change over time or due to temperature fluctuations, transport or aging. The tool therefore incorporates a feature that allows the settings to be checked and, if necessary, corrected by carrying out in-the-field re-calibration. This is done by setting up the tool securely on a tripod of good quality and targeting an easily visible, clearly discernible prism within ± 3 degrees of horizontal at a distance of approx. 50 - 70 m.



After this, follow the instructions on the display.

Tool parameters that are checked by in-the-field calibration and electronically adjusted:

- Target axis errors
- VA collimation errors
- Inclination errors of the tilt sensor (compensator)
- Axis errors of the automatic prism targeting system (prism tracker)



Laser pointer to cross hairs alignment error can be checked in the field. If the error is excessive, please contact the Hilti Tool Service or the Hilti Repair Service, as this error requires mechanical correction.

As the **Hilti** total station system is primarily used for measuring applications in one position, it is advisable to calibrate the tool in the field or on the construction site at regular intervals. This is especially the case when steeper sightings are used frequently.

14.2 Checking the laser point to the cross hairs

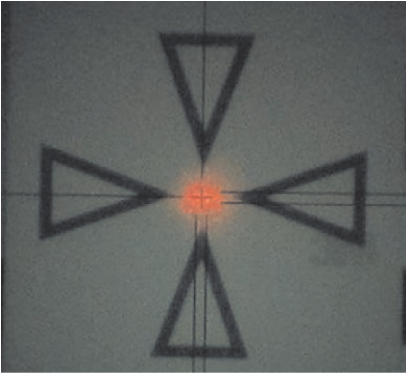

To check alignment of the laser point with the cross hairs, the following steps should be carried out:

1. Set up the POAW 82 target plate at a distance of approx. 30 m.
2. Align the position of the cross hairs with the center of the target plate. Aim for a position which is as horizontal as possible.
3. Switch on at the laser pointer.
Error in the form of deviation of the laser point from the center of the target plate must be no more than 5 mm (at 30 m).



If the deviation is greater than this, please contact the Hilti Tool Service or the **Hilti** Repair Service.

14.3 Procedure for “Calibration” application



The tool should be operated carefully in order to avoid vibrations.



The in-the-field calibration procedure requires great care and each step must be carried out very exactly. Imprecise sighting or vibration of the tool can result in incorrect calibration values, leading to subsequent measurement errors.



In the event of uncertainty, the tool should be returned to **Hilti** Service for checking.

Preparing for calibration

1. Set up the tool in a steady, secure position on a good tripod.
2. Select “Configuration” from the application menu.

1. System start dialog

- Use the Config button to select the Data Manager

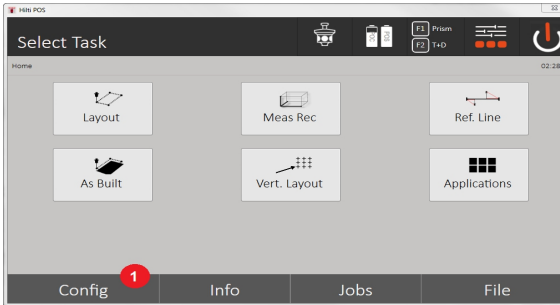

3. Call the calibration under Config

2. Configuration start dialog

- Start calibration in the Configuration menu

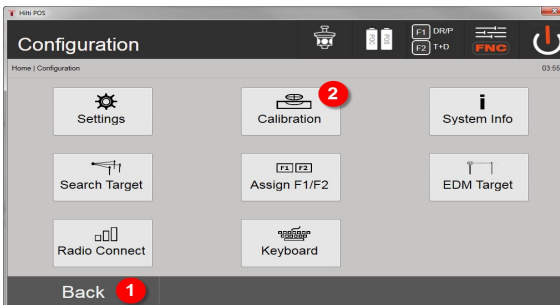

4. Return to “System” dialog

5. Start calibration

In the following sections, the sequence and procedure for the various calibrations are outlined.

14.3.1 Calibrating the tilt sensor

The tilt sensor is an important sensor in the total station system to ensure precise measurements in case of steep sightings.

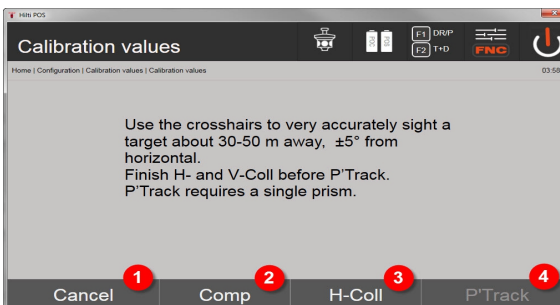

1. Return to configuration menu

2. Calibrate compensator option

3. Option for target axis and VA collimation calibration

4. Prism tracker calibration option

Procedure

5. Select option 2 to calibrate the compensator.

6. Do not touch the total station.

7. The total station will carry out measurements and rotate several times independently.

- The calibrating procedure is completed with the request to confirm the new deviations or to keep the "old" values.

14.3.2 Calibrating the target axis error and VA collimation error

The target axis error is the deviation of the optical sighting (target axis) from the mechanical / optical telescope axis. The VA collimation error is the deviation of the "zero direction" of the vertical circle from the mechanical vertical axis. This calibration is essential for safe and precise height measurements.

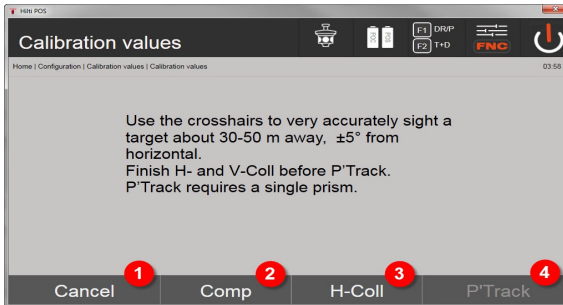

- Return to configuration menu
- Calibrate compensator option
- Option for target axis and VA collimation calibration
- Prism tracker calibration option

Procedure

- Once you have calibrated the compensator, select option 3 target axis and calibrate the VA collimation. Follow the instructions on the controller screen.
- Line up the selected target carefully with the cross hairs in telescope position 1 and follow the instructions on the screen.
- Once the measurement in telescope position 1 has been completed, the total station rotates automatically to telescope position 2.
- Line up the selected target carefully with the cross hairs in telescope position 2 and follow the instructions on the screen.
- The total station rotates back to position 1 and calculates and displays the new correction values.
- Decide whether you want to use the new values or keep the "old" calibration values.

14.3.3 Calibrating the prism tracker

The prism tracker is the automatic prism targeting and tracking function. The prism tracker error results when the prism tracker target axis deviates from the optical target axis. The tool may only be calibrated using one of the prisms supplied by Hilti. The safest is the large 360° prism POA 20 at a distance of 50 – 70 m without direct sunlight on the prism or in the objective lens aperture.



To calibrate the prism tracker, the target axis and VA collimation must first be calibrated.

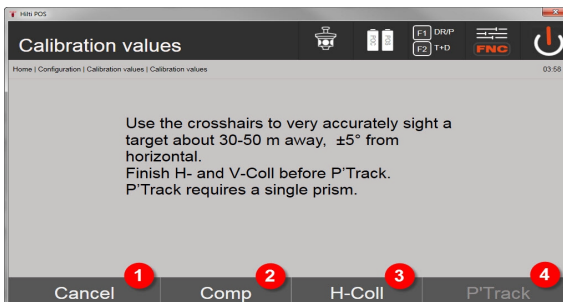

- Return to configuration menu

2. Calibrate compensator option
3. Option for target axis and VA collimation calibration
4. Prism tracker calibration option
5. After the target axis and VA collimation have been calibrated, the button for option 4 prism tracker is activated.
6. Carefully line up the prism in telescope position I in the cross hairs and follow the instructions on the controller screen.
7. When the measurement in position I is complete, the total station rotates to position II. Carefully line up the prism again and follow the instructions on the controller screen.
8. The total station rotates back into position I and calculates and displays the new correction values.
9. Decide whether you want to use the new values or keep the “old” calibration values.

Calibration is now completed.

14.3.4 Hilti Repair Service

The **Hilti** Repair Service checks the tool and, if deviations from the specified accuracy are found, recalibrates it and checks it again to ensure conformity with specifications. The Service Certificate provides written confirmation of conformity with specifications at the time of the check.

Recommendation

- Have the tool checked at suitable intervals, depending on how heavily it is used.
- Have the tool checked by the **Hilti** Repair Service at least once a year.
- Have the tool checked by the **Hilti** Repair Service if it has been subjected to exceptional stress or unusually harsh conditions.
- Have the tool checked by the **Hilti** Repair Service before using it for important work.

Having the tool checked by the **Hilti** Repair Service does not relieve the user of his/her obligation to check the tool before and during use.

15 Care and maintenance

 Have damaged parts replaced by **Hilti** Service.

15.1 Cleaning and drying

Blow any dust off the glass.

 Do not touch the glass surfaces with your fingers.

Use only a soft, clean cloth to clean the tool. If necessary, the cloth may be moistened with a little pure alcohol or water.

 Do not use liquids other than alcohol or water. Other liquids may damage plastic parts.

 Have damaged parts replaced by **Hilti** Service.

15.2 Storage

 Do not put the tool into storage when wet. Allow it to dry before putting it away.

 Always clean the tool, its transport container and accessories before putting them into storage.

 Check the accuracy of the equipment before it is used after a long period of storage or transportation.

 Remove the batteries if the tool is to remain unused for a long period of time. Leaking batteries may damage the tool.

 Observe the specified temperature limits when storing your equipment, above all in winter and summer, especially if the equipment is stored in a motor vehicle. (-30 °C to +70 °C (-22 °F to +158 °F)).

15.3 Transport

 The batteries must be insulated or removed from the tool before the tool is shipped or sent by mail. Leaking batteries may damage the tool.

Use the **Hilti** shipping box or packaging of equivalent quality for transporting or shipping your equipment.

16 Disposal

WARNING

Risk of injury. Hazards presented by improper disposal.

- ▶ Improper disposal of the equipment may have the following consequences: The burning of plastic components generates toxic fumes which may present a health hazard. Batteries may explode if damaged or exposed to very high temperatures, causing poisoning, burns, acid burns or environmental pollution. Careless disposal may permit unauthorized and improper use of the equipment. This may result in serious personal injury, injury to third parties and pollution of the environment.

 Most of the materials from which **Hilti** products are manufactured can be recycled. The materials must be correctly separated before they can be recycled. In many countries, your old tools, machines or appliances can be returned to **Hilti** for recycling. Ask **Hilti** Service or your Hilti sales representative for further information.

In accordance with the European Directive on waste electrical and electronic equipment and its implementation in conformance with national law, electric tools or appliances that have reached the end of their life must be collected separately and returned to an environmentally compatible recycling facility.



- ▶ Disposal of electric tools or appliances together with household waste is not permissible.

17 Manufacturer's warranty

- ▶ Please contact your local **Hilti** representative if you have questions about the warranty conditions.

18 FCC statement / IC statement

CAUTION This product has been tested and found to comply with the limits for a Class B digital device, pursuant to part 15 of the FCC Rules. These limits are designed to provide reasonable protection against harmful interference in a residential installation. These products generate, use and can radiate high frequencies and, if not installed and used in accordance with the instructions, may cause interference to radio communications.

There is no guarantee that interference will not occur in a particular installation. If this product does cause harmful interference to radio or television reception, which can be determined by turning the product off and on, the user is encouraged to try to correct the interference by taking the following measures:

- ▶ Re-orient or move the receiving antenna.
- ▶ Increase the distance between the product and receiver.
- ▶ Connect the product to a power outlet on a circuit other than that to which the receiver is connected.
- ▶ Consult your dealer or an experienced TV / radio technician for assistance.

Changes or modifications not expressly approved by **Hilti** may restrict the user's right to operate the product. This product complies with the requirements in Paragraph 15 of the FCC Rules and RSS 210 of IC.

Operation of the product is subject to the following conditions:

- ▶ This product should cause no harmful interference.
- ▶ This product must accept any interference received, including interference that may cause undesired operation.



Hilti Aktiengesellschaft
Feldkircherstraße 100
9494 Schaan | Liechtenstein

POS 150 / 180 (01)

[2012]

2014/53/EU

EN ISO 12100

2011/65/EU

EN 301489-1 V2.1.0

2006/66/EC

EN 301489-17 V3.1.0

EN 300328 V2.1.1

EN 61000-4-2

EN 61000-4-3

EN 61326-1

EN 55011

Schaan, 05/2017

Paolo Luccini

Head of BA Quality and
Process-Management
BA Electric Tools & Accessories

Thomas Hillbrand

Head of BU Measuring Systems
Business Unit Measuring Systems



Hilti Corporation
LI-9494 Schaan
Tel.: +423 234 21 11
Fax: +423 234 29 65
www.hilti.group



2164701



Hilti Connect